

**KEITHLEY**

# Model 2000 Multimeter

## Calibration Manual

A GREATER MEASURE OF CONFIDENCE

# WARRANTY

Keithley Instruments, Inc. warrants this product to be free from defects in material and workmanship for a period of 3 years from date of shipment.

Keithley Instruments, Inc. warrants the following items for 90 days from the date of shipment: probes, cables, rechargeable batteries, diskettes, and documentation.

During the warranty period, we will, at our option, either repair or replace any product that proves to be defective.

To exercise this warranty, write or call your local Keithley representative, or contact Keithley headquarters in Cleveland, Ohio. You will be given prompt assistance and return instructions. Send the product, transportation prepaid, to the indicated service facility. Repairs will be made and the product returned, transportation prepaid. Repaired or replaced products are warranted for the balance of the original warranty period, or at least 90 days.

## LIMITATION OF WARRANTY

This warranty does not apply to defects resulting from product modification without Keithley's express written consent, or misuse of any product or part. This warranty also does not apply to fuses, software, non-rechargeable batteries, damage from battery leakage, or problems arising from normal wear or failure to follow instructions.

**THIS WARRANTY IS IN LIEU OF ALL OTHER WARRANTIES, EXPRESSED OR IMPLIED, INCLUDING ANY IMPLIED WARRANTY OF MERCHANTABILITY OR FITNESS FOR A PARTICULAR USE. THE REMEDIES PROVIDED HEREIN ARE BUYER'S SOLE AND EXCLUSIVE REMEDIES.**

**NEITHER KEITHLEY INSTRUMENTS, INC. NOR ANY OF ITS EMPLOYEES SHALL BE LIABLE FOR ANY DIRECT, INDIRECT, SPECIAL, INCIDENTAL OR CONSEQUENTIAL DAMAGES ARISING OUT OF THE USE OF ITS INSTRUMENTS AND SOFTWARE EVEN IF KEITHLEY INSTRUMENTS, INC., HAS BEEN ADVISED IN ADVANCE OF THE POSSIBILITY OF SUCH DAMAGES. SUCH EXCLUDED DAMAGES SHALL INCLUDE, BUT ARE NOT LIMITED TO: COSTS OF REMOVAL AND INSTALLATION, LOSSES SUSTAINED AS THE RESULT OF INJURY TO ANY PERSON, OR DAMAGE TO PROPERTY.**

## KEITHLEY

Keithley Instruments, Inc.

28775 Aurora Road • Cleveland, Ohio 44139 • 440-248-0400 • Fax: 440-248-6168  
1-888-KEITHLEY (534-8453) • [www.keithley.com](http://www.keithley.com)

Sales Offices:	BELGIUM:	Bergensesteenweg 709 • B-1600 Sint-Pieters-Leeuw • 02-363 00 40 • Fax: 02/363 00 64
	CHINA:	Yuan Chen Xin Building, Room 705 • 12 Yumin Road, Dewai, Madian • Beijing 100029 • 8610-6202-2886 • Fax: 8610-6202-2892
	FINLAND:	Tietäjantie 2 • 02130 Espoo • Phone: 09-54 75 08 10 • Fax: 09-25 10 51 00
	FRANCE:	3, allée des Garays • 91127 Palaiseau Cédex • 01-64 53 20 20 • Fax: 01-60 11 77 26
	GERMANY:	Landsberger Strasse 65 • 82110 Germering • 089/84 93 07-40 • Fax: 089/84 93 07-34
	GREAT BRITAIN:	Unit 2 Commerce Park, Brunel Road • Theale • Berkshire RG7 4AB • 0118 929 7500 • Fax: 0118 929 7519
	INDIA:	Flat 2B, Willocrissa • 14, Rest House Crescent • Bangalore 560 001 • 91-80-509-1320/21 • Fax: 91-80-509-1322
	ITALY:	Viale San Gimignano, 38 • 20146 Milano • 02-48 39 16 01 • Fax: 02-48 30 22 74
	KOREA:	FL., URI Building • 2-14 Yangjae-Dong • Seocho-Gu, Seoul 137-130 • 82-2-574-7778 • Fax: 82-2-574-7838
	NETHERLANDS:	Postbus 559 • 4200 AN Gorinchem • 0183-635333 • Fax: 0183-630821
	SWEDEN:	c/o Regus Business Centre • Frosundaviks Allé 15, 4tr • 169 70 Solna • 08-509 04 679 • Fax: 08-655 26 10
	SWITZERLAND:	Kriesbachstrasse 4 • 8600 Dübendorf • 01-821 94 44 • Fax: 01-820 30 81
	TAIWAN:	1FL., 85 Po Ai Street • Hsinchu, Taiwan, R.O.C. • 886-3-572-9077 • Fax: 886-3-572-9031

© Copyright 2001 Keithley Instruments, Inc.  
Printed in the U.S.A.

---

# Model 2000 Multimeter Calibration Manual

©1994, Keithley Instruments, Inc.  
All rights reserved.  
Cleveland, Ohio, U.S.A.  
Fourth Printing December 2001  
Document Number: 2000-905-01 Rev. D

---

# Manual Print History

The print history shown below lists the printing dates of all Revisions and Addenda created for this manual. The Revision Level letter increases alphabetically as the manual undergoes subsequent updates. Addenda, which are released between Revisions, contain important change information that the user should incorporate immediately into the manual. Addenda are numbered sequentially. When a new Revision is created, all Addenda associated with the previous Revision of the manual are incorporated into the new Revision of the manual. Each new Revision includes a revised copy of this print history page.

Revision A (Document Number 2000-905-01) .....	November 1994
Addendum A (Document Number 2000-905-02).....	June 1995
Revision B (Document Number 2000-905-01) .....	June 2000
Revision C (Document Number 2000-905-01) .....	January 2001
Revision D (Document Number 2000-905-01) .....	December 2001

The following safety precautions should be observed before using this product and any associated instrumentation. Although some instruments and accessories would normally be used with non-hazardous voltages, there are situations where hazardous conditions may be present.

This product is intended for use by qualified personnel who recognize shock hazards and are familiar with the safety precautions required to avoid possible injury. Read and follow all installation, operation, and maintenance information carefully before using the product. Refer to the manual for complete product specifications.

If the product is used in a manner not specified, the protection provided by the product may be impaired.

The types of product users are:

**Responsible body** is the individual or group responsible for the use and maintenance of equipment, for ensuring that the equipment is operated within its specifications and operating limits, and for ensuring that operators are adequately trained.

**Operators** use the product for its intended function. They must be trained in electrical safety procedures and proper use of the instrument. They must be protected from electric shock and contact with hazardous live circuits.

**Maintenance personnel** perform routine procedures on the product to keep it operating properly, for example, setting the line voltage or replacing consumable materials. Maintenance procedures are described in the manual. The procedures explicitly state if the operator may perform them. Otherwise, they should be performed only by service personnel.

**Service personnel** are trained to work on live circuits, and perform safe installations and repairs of products. Only properly trained service personnel may perform installation and service procedures.

Keithley products are designed for use with electrical signals that are rated Installation Category I and Installation Category II, as described in the International Electrotechnical Commission (IEC) Standard IEC 60664. Most measurement, control, and data I/O signals are Installation Category I and must not be directly connected to mains voltage or to voltage sources with high transient over-voltages. Installation Category II connections require protection for high transient over-voltages often associated with local AC mains connections. Assume all measurement, control, and data I/O connections are for connection to Category I sources unless otherwise marked or described in the Manual.

Exercise extreme caution when a shock hazard is present. Lethal voltage may be present on cable connector jacks or test fixtures. The American National Standards Institute (ANSI) states that a shock hazard exists when voltage levels greater than 30V RMS, 42.4V peak, or 60VDC are present. **A good safety practice is to expect that hazardous voltage is present in any unknown circuit before measuring.**

Operators of this product must be protected from electric shock at all times. The responsible body must ensure that operators are prevented access and/or insulated from every connection point. In some cases, connections must be exposed to potential human contact. Product operators in these circumstances must be trained to protect themselves from the risk of electric shock. If the circuit is capable of operating at or above 1000 volts, **no conductive part of the circuit may be exposed.**

Do not connect switching cards directly to unlimited power circuits. They are intended to be used with impedance limited sources. NEVER connect switching cards directly to AC mains. When connecting sources to switching cards, install protective devices to limit fault current and voltage to the card.

Before operating an instrument, make sure the line cord is connected to a properly grounded power receptacle. Inspect the connecting cables, test leads, and jumpers for possible wear, cracks, or breaks before each use.

When installing equipment where access to the main power cord is restricted, such as rack mounting, a separate main input power disconnect device must be provided, in close proximity to the equipment and within easy reach of the operator.

For maximum safety, do not touch the product, test cables, or any other instruments while power is applied to the circuit under test. ALWAYS remove power from the entire test system and discharge any capacitors before: connecting or disconnecting cables or jumpers, installing or removing switching cards, or making internal changes, such as installing or removing jumpers.

Do not touch any object that could provide a current path to the common side of the circuit under test or power line (earth) ground. Always make measurements with dry hands while standing on a dry, insulated surface capable of withstanding the voltage being measured.

The instrument and accessories must be used in accordance with its specifications and operating instructions or the safety of the equipment may be impaired.

Do not exceed the maximum signal levels of the instruments and accessories, as defined in the specifications and operating information, and as shown on the instrument or test fixture panels, or switching card.

When fuses are used in a product, replace with same type and rating for continued protection against fire hazard.

Chassis connections must only be used as shield connections for measuring circuits, NOT as safety earth ground connections.

If you are using a test fixture, keep the lid closed while power is applied to the device under test. Safe operation requires the use of a lid interlock.

If a  screw is present, connect it to safety earth ground using the wire recommended in the user documentation.

The  symbol on an instrument indicates that the user should refer to the operating instructions located in the manual.

The  symbol on an instrument shows that it can source or measure 1000 volts or more, including the combined effect of normal and common mode voltages. Use standard safety precautions to avoid personal contact with these voltages.

The **WARNING** heading in a manual explains dangers that might result in personal injury or death. Always read the associated information very carefully before performing the indicated procedure.

The **CAUTION** heading in a manual explains hazards that could damage the instrument. Such damage may invalidate the warranty.

Instrumentation and accessories shall not be connected to humans.

Before performing any maintenance, disconnect the line cord and all test cables.

To maintain protection from electric shock and fire, replacement components in mains circuits, including the power transformer, test leads, and input jacks, must be purchased from Keithley Instruments. Standard fuses, with applicable national safety approvals, may be used if the rating and type are the same. Other components that are not safety related may be purchased from other suppliers as long as they are equivalent to the original component. (Note that selected parts should be purchased only through Keithley Instruments to maintain accuracy and functionality of the product.) If you are unsure about the applicability of a replacement component, call a Keithley Instruments office for information.

To clean an instrument, use a damp cloth or mild, water based cleaner. Clean the exterior of the instrument only. Do not apply cleaner directly to the instrument or allow liquids to enter or spill on the instrument. Products that consist of a circuit board with no case or chassis (e.g., data acquisition board for installation into a computer) should never require cleaning if handled according to instructions. If the board becomes contaminated and operation is affected, the board should be returned to the factory for proper cleaning/servicing.

---

# Table of Contents

## 1 Performance Verification

Introduction.....	1-2
Verification test requirements .....	1-3
Performing the verification test procedures .....	1-6
Verifying DC voltage .....	1-7
Verifying AC voltage .....	1-8
Verifying DC current .....	1-10
Verifying AC current.....	1-11
Verifying resistance .....	1-12

## 2 Calibration

Introduction.....	2-2
Environmental conditions .....	2-3
Calibration considerations .....	2-4
Calibration code.....	2-5
Comprehensive calibration .....	2-6
Front panel calibration .....	2-7
SCPI command calibration .....	2-14

## 3 Calibration Command Reference

Introduction.....	3-2
Command summary.....	3-4
Miscellaneous calibration commands.....	3-6
DC calibration commands .....	3-10
AC calibration commands .....	3-16
Manufacturing calibration .....	3-18
Bus error reporting.....	3-19
Detecting calibration step completion .....	3-20

## A Specifications

Accuracy calculations .....	A-7
Optimizing measurement accuracy.....	A-10
Optimizing measurement speed.....	A-11

## B Error Messages

## C Calibration Program

---

# List of Illustrations

## 1 Performance Verification

Connections for DC volts verification .....	1-7
Connections for AC volts verification .....	1-8
Connections for DC current verification .....	1-10
Connections for AC current verification.....	1-11
Connections for resistance verification (100Ω-10MΩ ranges) .....	1-12
Connections for resistance verification (100MΩ range) .....	1-13

## 2 Calibration

Low-thermal short connections .....	2-8
Calibrator connections for DC volts and ohms portion of comprehensive calibration .....	2-9
Connections for DC and AC amps comprehensive calibration .....	2-11
Connections for AC volts calibration .....	2-12
Synthesizer connections for manufacturing calibration .....	2-21



---

# List of Tables

## 1 Performance Verification

Recommended verification equipment .....	1-4
DCV reading limits .....	1-7
ACV reading limits .....	1-9
DCI limits .....	1-10
ACI limits .....	1-11
Limits for resistance verification .....	1-13

## 2 Calibration

Recommended equipment for comprehensive, DC only, or AC only calibration .....	2-6
Comprehensive calibration procedures .....	2-7
DC volts calibration summary .....	2-10
Ohms calibration summary .....	2-10
DC current calibration summary .....	2-11
Connections for AC volts calibration .....	2-12
AC current calibration summary .....	2-13
DC voltage calibration programming steps .....	2-16
Resistance calibration programming steps .....	2-16
DC current calibration programming steps .....	2-17
AC voltage calibration programming steps .....	2-18
AC current calibration programming steps .....	2-19
Recommended equipment for manufacturing calibration .....	2-20

## 3 Calibration Command Reference

Calibration command summary .....	3-4
DC calibration commands .....	3-10
AC calibration commands .....	3-16

## B Error Messages

Error summary .....	B-2
---------------------	-----



**1**

# Performance Verification

# Introduction

Use the procedures in this section to verify that the Model 2000 Multimeter accuracy is within the limits stated in the instrument's one-year accuracy specifications. You can perform verification procedures:

- When you first receive the instrument to make sure that it was not damaged during shipment, and that the unit meets factory specifications.
- When a question exists about the instrument's accuracy.
- Following calibration.

**WARNING** *The information in this section is intended only for qualified service personnel. Do not attempt these procedures unless you are qualified to do so.*

**NOTE** *If the instrument is still under warranty and its performance is outside specified limits, contact your Keithley representative or the factory to determine the correct course of action.*

This section includes the following information:

- **Verification test requirements:** Explains the test requirements.
- **Performing the verification procedures:** Provides general information about the test procedures.
- **Verifying DC voltage:** Provides the procedure to verify that the instrument meets its DC voltage accuracy specifications.
- **Verifying AC voltage:** Provides the procedure to verify AC voltage measurement accuracy.
- **Verifying DC current:** Outlines the procedure to test DC current measurement accuracy.
- **Verifying AC current:** Provides the procedure to verify AC current measurement accuracy.
- **Verifying resistance:** Provides the procedure to test resistance measurement accuracy.

# Verification test requirements

Be sure that you perform the verification tests:

- Under the proper environmental conditions.
- After the specified warm-up period.
- Using the correct line voltage.
- Using the proper calibration equipment.
- Using the specified reading limits.

## Environmental conditions

Conduct your performance verification procedures in a test environment that has:

- An ambient temperature of 18-28°C (65-82°F).
- A relative humidity of less than 80% unless otherwise noted.

## Line power

The Model 2000 Multimeter requires a line voltage of 100V/120V/220V/240V,  $\pm 10\%$  and a line frequency of 45Hz to 66Hz, or 360Hz to 440Hz.

## Warm-up period

Allow the Model 2000 Multimeter to warm up for at least one hour before conducting the verification procedures.

If the instrument has been subjected to temperature extremes (those outside the ranges stated above), allow additional time for the instrument's internal temperature to stabilize. Typically, allow one extra hour to stabilize a unit that is 10°C (18°F) outside the specified temperature range.

Also, allow the test equipment to warm up for the minimum time specified by the manufacturer.

## Recommended test equipment

Table 1-1 summarizes recommended verification equipment. Use the Fluke Model 5700A Calibrator (or the equivalent) to verify Model 2000 Multimeter measurement accuracy.

You can use alternate equipment as long as that equipment has specifications at least as good as those listed in Table 1-1. Keep in mind, however, that the calibrator will add to the uncertainty of each measurement. Table 1-1 lists the uncertainties of the recommended Fluke 5700A at each source value.

**Table 1-1**  
*Recommended verification equipment*

<b>Fluke 5700A Calibrator:</b>				
<b>DC voltage</b>	<b>AC voltage (1kHz, 50kHz)*</b>	<b>DC current</b>	<b>AC current (1kHz)</b>	<b>Resistance</b>
100mV: $\pm 14$ ppm 1.0V: $\pm 7$ ppm 10V: $\pm 5$ ppm 100V: $\pm 7$ ppm 1000V: $\pm 9$ ppm	100mV: $\pm 200$ ppm 1.0V: $\pm 82$ ppm 10V: $\pm 82$ ppm 100V: $\pm 90$ ppm 700V: $\pm 85$ ppm	10mA: $\pm 60$ ppm 100mA: $\pm 70$ ppm 1A: $\pm 110$ ppm 2.2A: $\pm 94$ ppm	1A: $\pm 690$ ppm 2.2A: $\pm 682$ ppm	100 $\Omega$ : $\pm 17$ ppm 1k $\Omega$ : $\pm 12$ ppm 10k $\Omega$ : $\pm 11$ ppm 100k $\Omega$ : $\pm 13$ ppm 1M $\Omega$ : $\pm 18$ ppm 10M $\Omega$ : $\pm 37$ ppm 100M $\Omega$ : $\pm 120$ ppm
<b>Fluke 5725A Amplifier:</b>				
AC Voltage, 50kHz: 700V, $\pm 375$ ppm				

\*1kHz specifications shown. 5725A amplifier required to source 700V @ 50kHz.  
90-day, 23°C  $\pm 5$ °C specifications shown.

NOTE: The Fluke 5725A amplifier is necessary only if you wish to verify the 750V AC range at 50kHz. Verification at 220V, 50kHz using only the 5700A calibrator is adequate for most applications.

## Verification limits

The verification limits stated in this section have been calculated using only the Model 2000 one-year accuracy specifications, and they do not include test equipment uncertainty. If a particular measurement falls slightly outside the allowable range, recalculate new limits based on both Model 2000 specifications and pertinent calibration equipment specifications.

### Example reading limit calculation

The following is an example of how reading limits have been calculated:

Assume you are testing the 10V DC range using a 10V input value. Using the Model 2000 one-year accuracy specification for 10V DC of  $\pm$  (30ppm of reading + 5ppm of range), the calculated limits are:

$$\text{Reading limits} = 10V \pm [(10V \times 30\text{ppm}) + (10V \times 5\text{ppm})]$$

$$\text{Reading limits} = 10V \pm (.0003 + .00005)$$

$$\text{Reading limits} = 10V \pm .00035V$$

$$\text{Reading limits} = 9.99965V \text{ to } 10.00035V$$

## Restoring factory defaults

Before performing the verification procedures, restore the instrument to its factory defaults as follows:

1. Press SHIFT and then SETUP. The instrument will display the following prompt:  
RESTORE: FACT

**NOTE** Pressing either range key toggles the RESTORE selection between USER and FACT.

2. Restore the factory default conditions by pressing ENTER.
3. Factory defaults will be set as follows:

Speed: medium

Filter: 10 readings

# Performing the verification test procedures

## Test summary

Verification test procedures include:

- DC volts
- AC volts
- DC current
- AC current
- Resistance

If the Model 2000 is not within specifications and not under warranty, see the calibration procedures in Section 2.

## Test considerations

When performing the verification procedures:

- Be sure to restore factory defaults as outlined above.
- Make sure that the equipment is properly warmed up and connected to the front panel input jacks. Also make sure that the front panel input jacks are selected with the INPUTS switch.
- Do not use autoranging for any verification tests because autorange hysteresis may cause the Model 2000 to be on an incorrect range. For each test signal, you must manually set the correct range for the Model 2000 using the range keys.
- Make sure the calibrator is in operate before you verify each measurement.
- Always let the source signal settle before taking a reading.
- Do not connect test equipment to the Model 2000 through a scanner or other switching equipment.

**WARNING** *The maximum common-mode voltage (voltage between INPUT LO and chassis ground is 500 V peak. Exceeding this value may cause a breakdown in insulation, creating a shock hazard. Some of the procedures in this section may expose you to dangerous voltages. Use standard safety precautions when such dangerous voltages are encountered to avoid personal injury caused by electric shock.*

## Verifying DC voltage

Check DC voltage accuracy by applying accurate DC voltages from the calibrator to the Model 2000 INPUT jacks and verifying that the display reads within specified limits. Follow these steps to verify the DC voltage:

1. Connect the Model 2000 HI and LO INPUT jacks to the DC voltage calibrator as shown in Figure 1-1.

**NOTE** Use shielded, low-thermal connections when testing the 100mV and 1V ranges to avoid errors caused by noise or thermal effects. Connect the shield to the calibrator's output LO terminal.

**Figure 1-1**  
Connections for  
DC volts verification

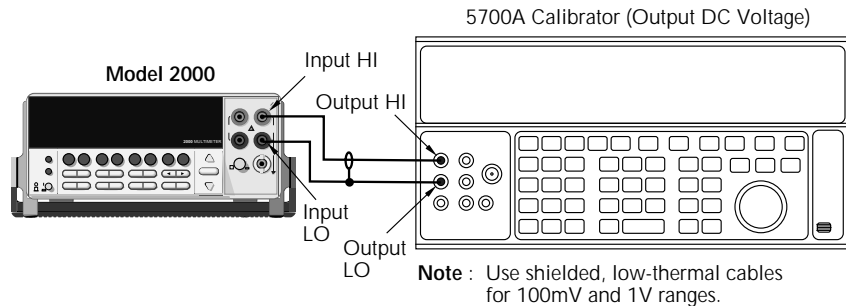

2. Select the DC volts function by pressing the DCV key, and set the Model 2000 to the 100mV range.
3. Set the calibrator output to 0.00000mV DC, and allow the reading to settle.
4. Enable the Model 2000 REL mode. Leave REL enabled for the remainder of the DC volts verification tests.
5. Source positive and negative full-scale voltages for each of the ranges listed in Table 1-2. For each voltage setting, be sure that the reading is within stated limits.

**Table 1-2**  
DCV reading limits

DCV Range	Applied DC voltage*	Reading limit (1 year, 18°C-28°C)
100mV	100.0000mV	99.9915 to 100.0085mV
1V	1.000000V	0.999963 to 1.000037V
10V	10.00000V	9.99965 to 10.00035V
100V	100.0000V	99.9949 to 100.0051V
1000V	1000.000V	999.939 to 1000.061V

\* Source positive and negative values for each range.



## Verifying AC voltage

Check AC voltage accuracy by applying accurate AC voltages at specific frequencies from the calibrator to the Model 2000 inputs and verifying that the display reads within specified limits.

**CAUTION** *Do not exceed 1000 V peak between INPUT HI and INPUT LO, or  $8 \times 10^7$  V•Hz input, because instrument damage may occur.*

Follow these steps to verify AC voltage accuracy:

1. Connect the Model 2000 HI and LO INPUT jacks to the AC voltage calibrator as shown in Figure 1-2.

**Figure 1-2**  
Connections for  
AC volts verification

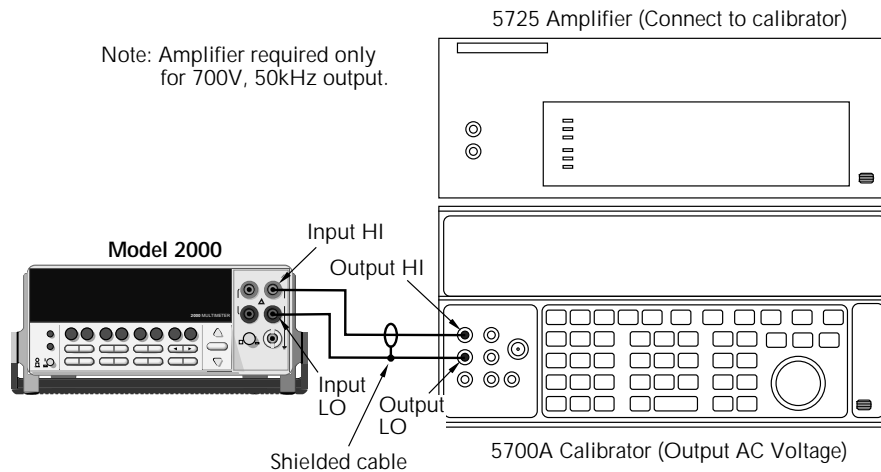

2. Select the AC volts function by pressing the ACV key.
3. Set the Model 2000 for the 100mV range; make sure that REL is disabled.
4. Source 1kHz and 50kHz AC voltages for each of the ranges summarized in Table 1-3, and make sure that the respective Model 2000 readings fall within stated limits.

**Table 1-3**  
ACV reading limits

ACV Range	Applied AC voltage	Reading limits (1 year, 18°C-28°C)	
		1kHz	50kHz
100mV	100.0000mV	99.9100 to 100.0900mV	99.8300 to 100.1700mV
1V	1.000000V	0.999100 to 1.000900V	0.998300 to 1.001700V
10V	10.00000V	9.99100 to 10.00900V	9.98300 to 10.01700V
100V	100.0000V	99.9100 to 100.0900V	99.8300 to 100.1700V
750V	700.000V*	699.355 to 700.645V	698.785 to 701.215V

\*If the 5725A amplifier is not available, change the 700V @ 50kHz step to 219V @ 50kHz.  
(Reading limits for 219V @ 50kHz = 218.362 to 219.638V.)

## Verifying DC current

Check DC current accuracy by applying accurate DC currents from the calibrator to the AMPS input of the Model 2000 and verifying that the display reads within specified limits. Follow these steps to verify DC current accuracy:

1. Connect the Model 2000 AMPS and INPUT LO jacks to the calibrator as shown in Figure 1-3.
2. Select the DC current measurement function by pressing the DCI key.
3. Set the Model 2000 for the 10mA range.
4. Source positive and negative full-scale currents for each of the ranges listed in Table 1-4, and verify that the readings for each range are within stated limits.

**Figure 1-3**  
Connections for  
DC current  
verification

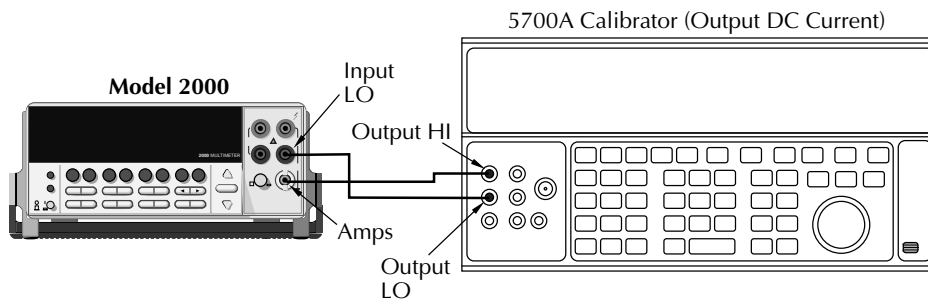

**Note:** Be sure calibrator is set for normal current output.

**Table 1-4**  
DCI limits

DCI Range	Applied DC current*	Reading limits (1 year, 18°C-28°C)
10mA	10.0000mA	9.99420 to 10.00580mA
100mA	100.0000mA	99.8700 to 100.1300mA
1A	1.000000A	0.999120 to 1.000880A
3A	2.20000A	2.19724 to 2.20276A

\* Source positive and negative currents with values shown.

## Verifying AC current

Check AC current accuracy by applying accurate AC current at specific frequencies from the calibrator to the Model 2000 input and verifying that the display reads within specified limits. Follow these steps to verify the AC current:

1. Connect the Model 2000 AMPS and INPUT LO jacks to the calibrator as shown in Figure 1-4.

**Figure 1-4**  
Connections for  
AC current verification

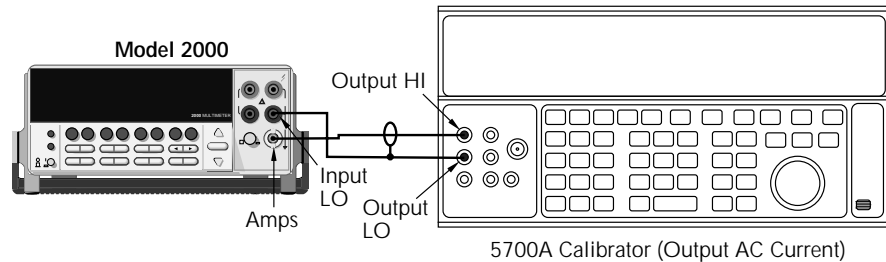

2. Select the AC current function by pressing the ACI key.
3. Set the Model 2000 for the 1A range.
4. Source 1A and 2.2A, 1kHz AC currents as summarized in Table 1-5, and verify that the readings are within stated limits.

**Table 1-5**  
ACI limits

ACI Range	Applied AC current	Reading limits (1 year, 18°C-28°C) 1kHz
1A	1.000000A	0.998600 to 1.001400A
3A	2.20000A	2.19490 to 2.20510A

## Verifying resistance

Check resistance by connecting accurate resistance values from the calibrator to the Model 2000 and verifying that its resistance readings are within the specified limits.

Follow these steps to verify resistance accuracy:

1. Using shielded 4-wire connections, connect the Model 2000 INPUT and SENSE jacks to the calibrator as shown in Figure 1-5.
2. Set the calibrator for 4-wire resistance with external sense on.
3. Select the Model 2000 4-wire resistance function by pressing the  $\Omega 4$  key.
4. Set the Model 2000 for the  $100\Omega$  range, and make sure the FILTER is on.
5. Recalculate the limits in Table 1-6 based on actual calibrator resistance values.
6. Source the nominal full-scale resistance values for  $100\Omega$ - $10M\Omega$  ranges summarized in Table 1-6, and verify that the readings are within stated limits.

**Figure 1-5**  
Connections for  
resistance verifi-  
cation ( $100\Omega$ -  
 $10M\Omega$  ranges)

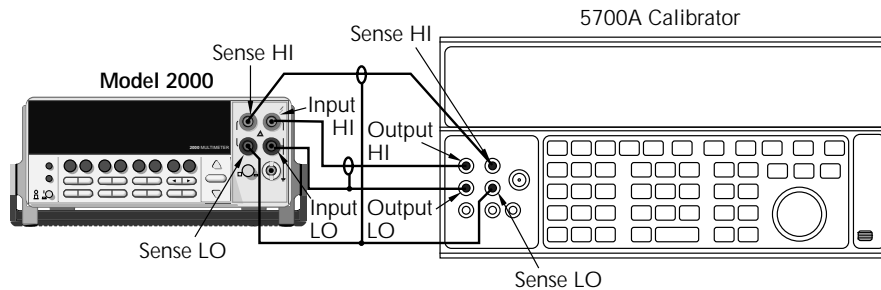

**Note :** Use shielded low-thermal cables to minimize noise. Enable or disable calibrator external sense as indicated in procedure.

7. Connect the Model 2000 INPUT and SENSE jacks to the calibrator as shown in Figure 1-6.
8. Disable external sense on the calibrator.
9. Set the Model 2000 to the  $100M\Omega$  range.
10. Source a nominal  $100M\Omega$  resistance value, and verify the reading is within the limits for the  $100M\Omega$  range listed in Table 1-6.

**Table 1-6**  
Limits for resistance verification

$\Omega$ Range	Nominal applied resistance	Nominal reading limits (1 year, 18°C-28°C)	Recalculated limits	
			Low limit	High limit
100 $\Omega$	100 $\Omega$	99.9860 to 100.0140 $\Omega$	_____	_____
1k $\Omega$	1k $\Omega$	0.999890 to 1.000110k $\Omega$	_____	_____
10k $\Omega$	10k $\Omega$	9.99890 to 10.00110k $\Omega$	_____	_____
100k $\Omega$	100k $\Omega$	99.9890 to 100.0110k $\Omega$	_____	_____
1M $\Omega$	1M $\Omega$	0.999890 to 1.000110M $\Omega$	_____	_____
10M $\Omega$	10M $\Omega$	9.99590 to 10.00410M $\Omega$	_____	_____
100M $\Omega$	100M $\Omega$	99.8470 to 100.1530M $\Omega$	_____	_____

**Figure 1-6**  
Connections for resistance verification (100M $\Omega$  range)

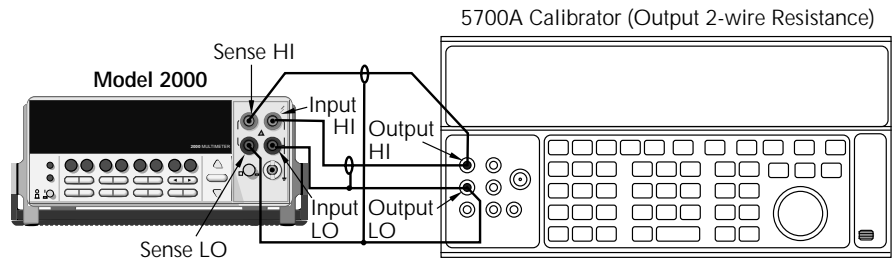

**Note :** Use shielded cables to minimize noise.  
Disable calibrator external sense mode.

---

# 2 Calibration

# Introduction

Use the procedures in this section to calibrate the Model 2000. Calibration procedures include:

- **Comprehensive calibration:** Calibrate DC and AC voltages, DC and AC currents, and resistance values.
- **Manufacturing calibration:** Usually only performed at the factory.

**WARNING** *This information in this section is intended only for qualified service personnel. Do not attempt these procedures unless you are qualified to do so.*

All the procedures require accurate calibration equipment to supply precise DC and AC voltages, DC and AC currents, and resistance values. Comprehensive AC and DC calibration can be performed any time by a technician either from the front panel, or by using the SCPI commands sent either over the IEEE-488 bus or the RS-232 link.

**NOTE** *Manufacturing calibration is required in the field only if the Model 2000 has been repaired.*

This section includes the following information:

**Environmental conditions:** Explains the type of environment needed for calibration.

**Calibration considerations:** Summarizes test conditions to observe when performing calibration.

**Calibration code:** Explains how to enter the calibration code to unlock Model 2000 calibration.

**Comprehensive calibration:** Summarizes the calibration cycle and also lists recommended comprehensive calibration equipment.

**Front panel calibration:** Provides the calibration procedures using the front panel.

**SCPI command calibration:** Provides the detailed procedures for calibrating the Model 2000 using SCPI commands.

**Manufacturing calibration:** Explains the manufacturing calibration procedure using both the front panel and SCPI commands.



## Environmental conditions

Conduct the calibration procedures in a location that has:

- An ambient temperature of  $23^{\circ}\text{C} \pm 5^{\circ}\text{C}$
- A relative humidity of less than 80% unless otherwise noted

### Warm-up period

Allow the Model 2000 Multimeter to warm up for at least one hour before performing calibration.

If the instrument has been subjected to temperature extremes (those outside the ranges stated in the above section) allow extra time for the instrument's internal temperature to stabilize. Typically, allow one extra hour to stabilize a unit that is  $10^{\circ}\text{C}$  ( $18^{\circ}\text{F}$ ) outside the specified temperature range.

Also, allow the test equipment to warm up for the minimum time specified by the manufacturer.

### Line power

The Model 2000 Multimeter requires a line voltage of 100V/120V/220V/240V,  $\pm 10\%$  and a line frequency of 45Hz to 66Hz or 360Hz to 440Hz.

## Calibration considerations

When performing the calibration procedures:

- Make sure that the equipment is properly warmed up and connected to the appropriate input jacks. Also make sure that the correct input jacks are selected with the INPUTS switch.
- Make sure the calibrator is in operate before you complete each calibration step.
- Always let the source signal settle before calibrating each point.
- Do not connect test equipment to the Model 2000 through a scanner or other switching equipment.
- If an error occurs during calibration, the Model 2000 will generate an appropriate error message. See Section 3 and Appendix B for more information.

**WARNING** *The maximum common-mode voltage (voltage between INPUT LO and chassis ground) is 500 V peak. Exceeding this value may cause a breakdown in insulation, creating a shock hazard. Some of the procedures in this section may expose you to dangerous voltages. Use standard safety precautions when such dangerous voltages are encountered to avoid personal injury caused by electric shock.*

---

# Calibration code

## Comprehensive calibration code

Before performing comprehensive (user) calibration, you must first unlock calibration by entering the appropriate calibration code.

### Front panel calibration code

For front panel calibration, follow these steps:

1. Access the calibration menu by pressing SHIFT then CAL, and note that the instrument displays the following:  
CAL: DATES
2. Use the up or down range keys to scroll through the available calibration parameters until the unit displays RUN, then press ENTER.
3. The Model 2000 then prompts you to enter a code. (The factory default code is 002000.) Use the left and right arrow keys to move among the digits; use the up range key to increment numbers, and press the down range key to specify alphabetic letters. Confirm the code by pressing ENTER.
4. The Model 2000 allows you to define a new calibration code. Use the up and down range keys to toggle between yes and no. Choose N if you do not want to change the code. Choose Y if you want to change the code. The unit then prompts you to enter a new code. Enter the code, and press ENTER.

## Programming the calibration code

If you are performing calibration over the IEEE-488 bus or the RS-232 link, send this command to unlock the calibration lock:

```
:CAL:PROT:CODE <up to 8-character string>
```

The default code command is:

```
:CAL:PROT:CODE 'KI002000'
```

## Manufacturing calibration lock

To unlock manufacturing calibration, press and hold the front panel OPEN key while turning on the power. See Manufacturing calibration at the end of this section for procedures.

## Comprehensive calibration

The comprehensive calibration procedure calibrates the DCV, DCI, ACV, ACI, and ohms functions. You can also choose to calibrate only DCV/DCI and resistance, or the ACV/ACI functions.

These procedures are usually the only ones required in the field. Manufacturing calibration is done at the factory and should be done if the unit has been repaired in the field. See the Manufacturing calibration paragraph at the end of this section for more information.

### Calibration cycle

Perform comprehensive calibration at least once a year, or every 90 days to ensure the unit meets the corresponding specifications.

### Recommended equipment

Table 2-1 lists the recommended equipment you need for comprehensive, DC only, and AC only calibration procedures. You can use alternate equipment, such as a DC transfer standard and characterized resistors, as long that equipment has specifications at least as good as those listed in the table.

**Table 2-1**

*Recommended equipment for comprehensive, DC only, or AC only calibration*

<b>Fluke 5700A Calibrator</b>				
<b>DC voltage</b>	<b>AC voltage (1kHz, 50kHz)*</b>	<b>DC current</b>	<b>AC current (1kHz)</b>	<b>Resistance</b>
10V: $\pm 5$ ppm 100V: $\pm 7$ ppm	10mV: $\pm 710$ ppm 100mV: $\pm 200$ ppm 1.0V: $\pm 82$ ppm 10V: $\pm 82$ ppm 100V: $\pm 90$ ppm 700V: $\pm 85$ ppm	10mA: $\pm 60$ ppm 100mA: $\pm 70$ ppm 1A: $\pm 110$ ppm	100mA: $\pm 190$ ppm 1A: $\pm 690$ ppm 2A: $\pm 670$ ppm	1k $\Omega$ : $\pm 12$ ppm 10k $\Omega$ : $\pm 11$ ppm 100k $\Omega$ : $\pm 13$ ppm 1M $\Omega$ : $\pm 18$ ppm
<b>Keithley 8610 Low-thermal shunting plug</b>				

\*1kHz specifications. 10mV and 700V points require 1kHz only.  
All calibration specifications are 90-day, 23°  $\pm 5^\circ\text{C}$  specifications.

### Canceling calibration

You can cancel the calibration process at any time by pressing EXIT.

# Front panel calibration

Follow the steps in the following paragraphs for comprehensive, DC only, and AC only calibration procedures.

The procedures for front panel calibration include:

- Preparing the Model 2000 for calibration
- Front panel short and open calibration
- DC voltage calibration
- Resistance calibration
- DC current calibration
- AC voltage calibration
- AC current calibration
- Setting calibration dates

## Preparing the Model 2000 for calibration

1. Turn on the Model 2000, and allow it to warm up for at least one hour before performing the calibration procedure.
2. Select the DCV function and choose SLOW as the RATE (integration time = 10 PLC).
3. Start the calibration process as follows:
  - A. Access the calibration menu by pressing SHIFT then CAL.
  - B. Use the up and down range keys to scroll through the available calibration menu items until the unit displays RUN, then press ENTER.
  - C. At the prompt, enter the calibration code. (The default code is 002000.) Use the left and right arrow keys to move among the digits; use the up range key to increment numbers, and press the down range key to specify alphabetic letters. Confirm the code by pressing ENTER.
  - D. Choose N at the prompt to proceed without changing the code, then press ENTER.
4. Choose which of the the calibration tests summarized in Table 2-2 you want to run at the CAL: RUN prompt. Use the up and down range keys to scroll through the options; select your choice by pressing ENTER.

**Table 2-2**  
*Comprehensive calibration procedures*

Procedure	Menu choice	Procedures
Full calibration	ALL	All comprehensive calibration steps.
DCV, DCI, and ohms	DC	DC voltage, DC current, and resistance calibration.
ACV and ACI	AC	AC voltage and AC current calibration.

## Front panel short and open calibration

At the Model 2000 prompt for a front panel short, do the following:

1. Connect the Model 8610 low-thermal short to the instrument front panel INPUT and SENSE terminals as shown in Figure 2-1. Make sure the INPUTS button is not pressed in so that the front inputs are selected. Wait at least three minutes before proceeding to allow for thermal equilibrium.

**NOTE** Be sure to connect the low-thermal short properly to the HI, LO, and SENSE terminals. Keep drafts away from low-thermal connections to avoid thermal drift, which could affect calibration accuracy.

**Figure 2-1**  
Low-thermal  
short connections

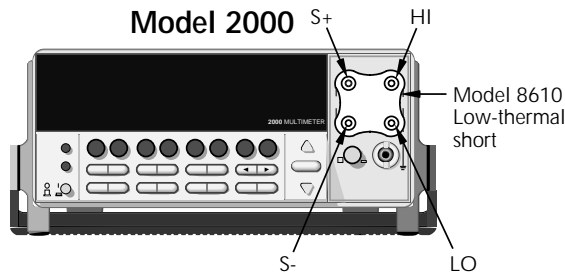

2. Press ENTER to start short-circuit calibration. While the unit is calibrating, the unit will display:  
CALIBRATING
3. When the unit is done calibrating, it will display the following prompt:  
OPEN CIRCUIT
4. Remove the calibration short, and press ENTER. During this phase, the CALIBRATING message will be displayed.

## DC voltage calibration

After the front panel short and open procedure, the unit will prompt you for the first DC voltage: +10V. Do the following:

1. Connect the calibrator to the Model 2000 as shown in Figure 2-2. Wait three minutes to allow for thermal equilibrium before proceeding.

**NOTE** Although 4-wire connections are shown, the sense leads are connected and disconnected at various points in this procedure by turning calibrator external sense on or off as appropriate. If your calibrator does not have provisions for turning external sense on and off, disconnect the sense leads when external sensing is to be turned off, and connect the sense leads when external sensing is to be turned on.

**Figure 2-2**  
Calibrator connections for DC volts and ohms portion of comprehensive calibration

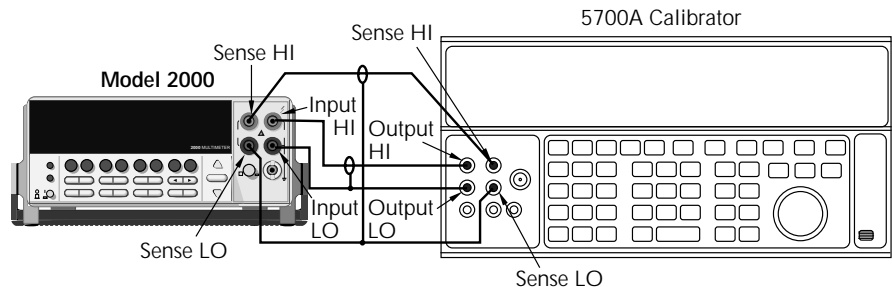

**Note :** Use shielded low-thermal cables to minimize noise. Enable or disable calibrator external sense as indicated in procedure.

2. Set the calibrator to output DC volts, and turn external sense off.
3. Perform the steps listed in Table 2-3 to complete DC volts calibration. For each calibration step:
  - Set the calibrator to the indicated value, and make sure it is in operate.
  - Press the ENTER key to calibrate that step.
  - Wait until the Model 2000 finishes each step. (The unit will display the CALIBRATING message while calibrating.)

**NOTE** If your calibrator cannot output the values recommended in Table 2-3, use the left and right arrow keys, and the up and down range keys to set the Model 2000 display value to match the calibrator output voltage.

**Table 2-3**  
DC volts calibration summary

Calibration step	Calibrator voltage	Allowable range
+10V	+10.00000V	+9V to +11V
-10V	-10.00000V	-9V to -11V
100V	+100.0000V	+90V to +110V

## Resistance calibration

Completing the 100V DC calibration step ends the DC voltage calibration procedure. The Model 2000 will then prompt you to connect 1 k $\Omega$ . Follow these steps for resistance calibration:

1. Set the calibrator output for resistance, and turn on external sense.

**NOTE** Use external sense (4-wire  $\Omega$ ) when calibrating all resistance ranges. Be sure that the calibrator external sense mode is turned on.

2. Perform the calibration steps summarized in Table 2-4. For each step:
  - Set the calibrator to the indicated value, and place the unit in operate. (If the calibrator cannot output the exact resistance value, use the Model 2000 left and right arrow keys and the range keys to adjust the Model 2000 display to agree with the calibrator resistance.)
  - Press the ENTER key to calibrate each point.
  - Wait for the Model 2000 to complete each step before continuing.

**Table 2-4**  
Ohms calibration summary

Calibration step	Calibrator resistance*	Allowable range
1k $\Omega$	1k $\Omega$	0.9k $\Omega$ to 1.1k $\Omega$
10k $\Omega$	10k $\Omega$	9k $\Omega$ to 11k $\Omega$
100k $\Omega$	100k $\Omega$	90k $\Omega$ to 110k $\Omega$
1M $\Omega$	1M $\Omega$	0.9M $\Omega$ to 1.1M $\Omega$

\* Nominal resistance. Adjust Model 2000 calibration parameter to agree with actual value.



## DC current calibration

After the  $1\text{M}\Omega$  resistance point has been calibrated, the unit will prompt you for 10mA. Follow these steps for DC current calibration:

1. Connect the calibrator to the AMPS and INPUT LO terminals of the Model 2000 as shown in Figure 2-3.

**Figure 2-3**  
Connections for  
DC and AC amps  
comprehensive  
calibration

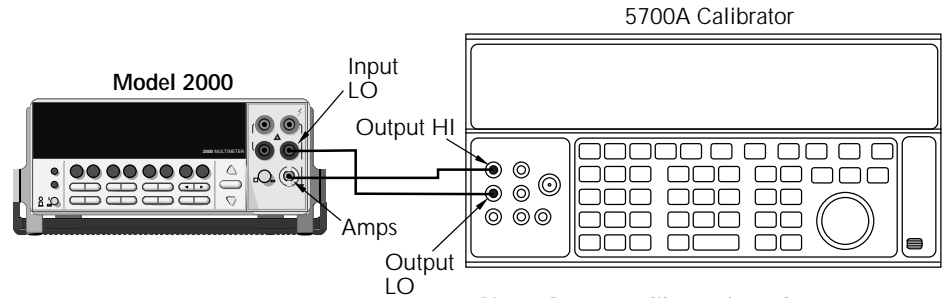

**Note:** Be sure calibrator is set for normal current output.

2. Calibrate each current step summarized in Table 2-5. For each step:
  - Set the calibrator to the indicated DC current, and make sure the unit is in operate.
  - Make sure the Model 2000 display indicates the correct calibration current.
  - Press ENTER to complete each step.
  - Allow the Model 2000 to finish each step.

**NOTE** If you are performing DC-only calibrator, proceed to the “Setting calibration dates” paragraph.

**Table 2-5**  
DC current calibration summary

Calibration step	Calibrator current	Allowable range
10mA	10.00000mA	9mA to 11mA
100mA	100.0000mA	90mA to 110mA
1A	1.00000A	0.9A to 1.1A

## AC voltage calibration

Follow these steps for AC voltage calibration:

1. Connect the calibrator to the Model 2000 INPUT HI and LO terminals as shown in Figure 2-4.

**Figure 2-4**  
Connections for  
AC volts calibration

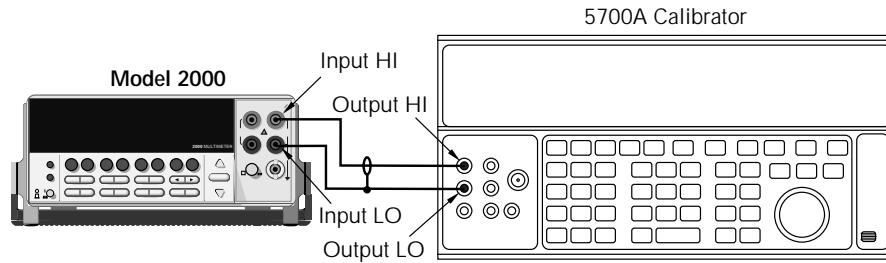

2. Perform the calibration steps summarized in Table 2-6. For each step:
  - Set the calibrator to the indicated value, and make sure the calibrator is in operate.
  - Press ENTER to complete each step.
  - Wait until the Model 2000 completes each step.

**Table 2-6**  
AC voltage calibration summary

Calibration step	Calibrator voltage, frequency
10mV AC at 1kHz	10.00000mV, 1kHz
100mV AC at 1kHz	100.0000mV, 1kHz
100mV AC at 50kHz	100.0000mV, 50kHz
1V AC at 1kHz	1.000000V, 1kHz
1V AC at 50kHz	1.000000V, 50kHz
10V AC at 1kHz	10.00000V, 1kHz
10V AC at 50kHz	10.00000V, 50kHz
100V AC at 1kHz	100.0000V, 1kHz
100V AC at 50kHz	100.0000V, 50kHz
700V AC at 1kHz	700.000V, 1kHz

## AC current calibration

After the 700VAC at 1kHz point has been calibrated, the unit will prompt you for 100mA at 1kHz. Follow these steps for AC current calibration:

1. Connect the calibrator to the AMPS and INPUT LO terminals of the Model 2000 as shown in Figure 2-3.
2. Perform the calibration steps summarized in Table 2-7. For each step:
  - Set the calibrator to the indicated current and frequency, and make sure the unit is in operate.
  - Press ENTER to complete each calibration step.
  - Allow the unit to complete each step before continuing.

**Table 2-7**

*AC current calibration summary*

Calibration step	Calibrator voltage, frequency
100mA at 1kHz	100.0000mA, 1kHz
1A at 1kHz	1.000000A, 1kHz
2A at 1kHz	2.000000A, 1kHz

## Setting calibration dates

At the end of the calibration procedure, the instrument will display the CALIBRATION COMPLETE message. Press ENTER to continue, and the the Model 2000 will prompt you to enter the calibration date and the calibration due date. Set these dates as follows:

1. At the CAL DATE: mm/dd/yy prompt, use the left and right arrow keys, and the range keys to set the calibration date, then press ENTER.
2. The unit will then prompt you to enter the next calibration due date with this prompt: CAL NDUE: mm/dd/yy. Use the left and right arrow keys, and the range keys to set the calibration due date, then press ENTER.
3. The unit will prompt you to save new calibration constants with this message: SAVE CAL? YES. To save the new constants, press ENTER. If you do not want to save the new constants, press the down range key to toggle to NO, then press ENTER.

**NOTE** Calibration constants calculated during the current calibration procedure will not be saved unless you choose the YES option. Previous calibration constants will be retained if you select NO.

## SCPI command calibration

Follow the steps in this section to use SCPI commands to perform comprehensive, DC only, and AC only calibration procedures. See Section 3 for a detailed list and description of SCPI calibration commands.

When sending calibration commands, be sure that the Model 2000 completes each step before sending the next command. You can do so either by observing the front panel CALIBRATING message, or by Detecting the completion of each step over the bus. (See “Detecting calibration step completion” at the end of Section 3.)

The procedures for calibrating the Model 2000 using SCPI commands include:

- Preparing the Model 2000 for calibration
- Front panel short and open calibration
- DC voltage calibration
- Resistance calibration
- DC current calibration
- AC voltage calibration
- AC current calibration
- Programming calibration dates
- Saving calibration constants
- Locking out calibration

**NOTE** *As with front panel calibration, you can choose to perform complete, DC-only, or AC-only calibration. When sending calibration commands, be sure to include a space character between each command and parameter.*

### Preparing the Model 2000 for calibration

1. Connect the Model 2000 to the IEEE-488 bus of the computer using a shielded IEEE-488 cable, such as the Keithley Model 7007, or connect the unit to a computer through an RS-232 port using a straight-through 9-pin to 9-pin cable (use a 9-25-pin adapter if necessary).
2. Turn on the Model 2000, and allow it to warm up for an hour before performing calibration.
3. Select the DCV function and choose SLOW as the RATE (integration time = 10 PLC).
4. Make sure the primary address of the Model 2000 is the same as the address specified in the program that you will be using to send commands. (Use the GPIB key.)
5. Unlock the calibration function by sending this command:

```
:CAL:PROT:CODE 'KI002000'
```

(The above command shows the default code, KI002000. Substitute the correct code if changed.)

6. Send the following command to initiate calibration:

```
:CAL:PROT:INIT
```

---

## Front panel short and open calibration

1. Connect the Model 8610 low-thermal short to the instrument INPUT and SENSE terminals as shown in Figure 2-1. Make sure the INPUTS button is not pressed in so that the front inputs are active. Wait at least three minutes before proceeding to allow for thermal equilibrium.

**NOTE** *Be sure to connect the low-thermal short properly to the HI, LO, and SENSE terminals. Keep drafts away from low-thermal connections to avoid thermal drift, which could affect calibration accuracy.*

2. Send the following command:  
:CAL:PROT:DC:STEP1
3. After the Model 2000 completes this step, remove the short, and send this command:  
:CAL:PROT:DC:STEP2

## DC voltage calibration

After front panel short and open steps, do the following:

1. Connect the calibrator to the Model 2000 as shown in Figure 2-2. Allow three minutes for thermal equilibrium.

**NOTE** *Although 4-wire connections are shown, the sense leads are connected and disconnected at various points in this procedure by turning calibrator external sense on or off as appropriate. If your calibrator does not have provisions for turning external sense on and off, disconnect the sense leads when external sensing is to be turned off, and connect the sense leads when external sensing is to be turned on.*

2. Perform the calibration steps summarized in Table 2-8. For each step:
  - Set the calibrator to the indicated voltage, and make sure the unit is in operate. (Use the recommended voltage if possible.)
  - Send the indicated programming command.
  - Wait until the Model 2000 completes each step before continuing.

**Table 2-8**  
DC voltage calibration programming steps

Calibration step	Calibrator voltage	Calibration command*	Parameter range
+10V	+10.00000V	:CAL:PROT:DC:STEP3 10	9 to 11
-10V	-10.00000V	:CAL:PROT:DC:STEP4 -10	-9 to -11
100V	100.0000V	:CAL:PROT:DC:STEP5 100	90 to 110

\* Change parameter accordingly if using a different calibrator voltage.

## Resistance calibration

Follow these steps for resistance calibration:

1. Set the calibrator to the resistance mode, and turn on external sensing.

**NOTE** Use external sense (4-wire  $\Omega$ ) when calibrating all resistance ranges. Be sure that the calibrator external sense mode is turned on.

2. Perform the calibration steps summarized in Table 2-9. For each step:
  - Set the calibrator to the indicated resistance, and make sure the unit is in operate. (Use the recommended resistance or the closest available value.)
  - Send the indicated programming command. (Change the command parameter if you are using a different calibration resistance than that shown.)
  - Wait until the Model 2000 completes each step before continuing.

**Table 2-9**  
Resistance calibration programming steps

Calibration step	Calibrator resistance	Calibration command*	Parameter range
1k $\Omega$	1k $\Omega$	:CAL:PROT:DC:STEP6 1E3	900 to 1.1E3
10k $\Omega$	10k $\Omega$	:CAL:PROT:DC:STEP7 10E3	9E3 to 11E3
100k $\Omega$	100k $\Omega$	:CAL:PROT:DC:STEP8 100E3	90E3 to 110E3
1M $\Omega$	1M $\Omega$	:CAL:PROT:DC:STEP9 1E6	900E3 to 1.1E6

\* Use exact calibrator resistance value for parameter.

## DC current calibration

After the 1M $\Omega$  resistance point has been calibrated, follow these steps for DC current calibration:

1. Connect the calibrator to the AMPS and INPUT LO terminals of the Model 2000 as shown in Figure 2-3.
2. Perform the calibration steps listed in Table 2-10. For each step:
  - Set the calibrator to the indicated current, and make sure the unit is in operate. (Use the recommended current if possible.)
  - Send the indicated programming command. (Change the current parameter if you are using a different calibration current.)
  - Wait until the Model 2000 completes each step before continuing.

**NOTE** *If you are performing DC-only calibration, proceed to the “Programming calibration dates” paragraph.*

**Table 2-10**

*DC current calibration programming steps*

Calibration step	Calibrator current	Calibration command*	Parameter range
10mA	10.00000mA	:CAL:PROT:DC:STEP10 10E-3	9E-3 to 11E-3
100mA	100.00000mA	:CAL:PROT:DC:STEP11 100E-3	90E-3 to 110E-3
1A	1.000000A	:CAL:PROT:DC:STEP12 1	0.9 to 1.1

\* Change parameter if using a different current.

## AC voltage calibration

Follow these steps for AC voltage calibration:

1. Connect the calibrator to the Model 2000 INPUT HI and LO terminals as shown in Figure 2-4.
2. Perform the calibration steps summarized in Table 2-11. For each step:
  - Set the calibrator to the indicated voltage and frequency, and make sure the unit is in operate. (You must use the stated voltage and frequency.)
  - Send the indicated programming command.
  - Wait until the Model 2000 completes each step before continuing.

**Table 2-11**

*AC voltage calibration programming steps*

Calibration step	Calibrator voltage, frequency	Calibration command
10mV AC at 1kHz	10.00000mV, 1kHz	:CAL:PROT:AC:STEP1
100mV AC at 1kHz	100.0000mV, 1kHz	:CAL:PROT:AC:STEP2
100mV AC at 50kHz	100.0000mV, 50kHz	:CAL:PROT:AC:STEP3
1VAC at 1kHz	1.000000V, 1kHz	:CAL:PROT:AC:STEP4
1VAC at 50kHz	1.000000V, 50kHz	:CAL:PROT:AC:STEP5
10VAC at 1kHz	10.00000V, 1kHz	:CAL:PROT:AC:STEP6
10VAC at 50kHz	10.00000V, 50kHz	:CAL:PROT:AC:STEP7
100VAC at 1kHz	100.0000V, 1kHz	:CAL:PROT:AC:STEP8
100VAC at 50kHz	100.0000V, 50kHz	:CAL:PROT:AC:STEP9
700VAC at 1kHz	700.000V, 1kHz	:CAL:PROT:AC:STEP10

## AC current calibration

Follow these steps for AC current calibration:

1. Connect the calibrator to the AMPS and INPUT LO terminals of the Model 2000 as shown in Figure 2-3.
2. Perform the calibration steps summarized in Table 2-12. For each step:
  - Set the calibrator to the indicated current and frequency, and make sure the unit is in operate. (You must use the stated current and frequency.)
  - Send the indicated programming command.
  - Wait until the Model 2000 completes each step before continuing.



**Table 2-12**  
AC current calibration programming steps

Calibration step	Calibrator current, frequency	Calibration command
100mA at 1kHz	100.0000mA, 1kHz	:CAL:PROT:AC:STEP11
1A at 1kHz	1.000000A, 1kHz	:CAL:PROT:AC:STEP12
2A at 1kHz	2.000000A, 1kHz	:CAL:PROT:AC:STEP13

## Programming calibration dates

Program the present calibration date and calibration due date by sending the following commands:

```
:CAL:PROT:DATE <year>, <month>, <day>
:CAL:PROT:NDUE <year>, <month>, <day>
```

For example, the following commands assume calibration dates of 12/15/95 and 3/14/96 respectively:

```
:CAL:PROT:DATE 1995, 12, 15
:CAL:PROT:NDUE 1996, 3, 14
```

## Saving calibration constants

After completing the entire calibration procedure, send the following command to save the new calibration constants:

```
:CAL:PROT:SAVE
```

**NOTE** Calibration constants will not be saved unless the *:SAVE* command is sent.

## Locking out calibration

After saving calibration, send the following command to lock out calibration:

```
:CAL:PROT:LOCK
```

## Manufacturing calibration

The manufacturing procedure is normally performed only at the factory, but the necessary steps are included here in case the unit is repaired, and the unit requires these calibration procedures.

**NOTE** *If the unit has been repaired, the entire comprehensive calibration procedure should also be performed in addition to the manufacturing calibration procedure.*

### Recommended test equipment

Table 2-13 summarizes the test equipment required for the manufacturing calibration steps. In addition, you will need the Fluke 5700A Calibrator (see Table 2-1) to complete the comprehensive calibration steps.

**Table 2-13**  
*Recommended equipment for manufacturing calibration*

<p><b>Keithley 3930A or 3940 Frequency Synthesizer:</b></p> <p>1V RMS, 3Hz: <math>\pm 5</math>ppm 1V RMS, 1kHz: <math>\pm 5</math>ppm</p>
<p><b>Keithley Model 2001 or 2002 DMM:</b></p> <p>1V, 3Hz AC, <math>\pm 0.13\%</math></p>
<p><b>Keithley Model 8610 Low-thermal shorting plug</b></p>

### Unlocking manufacturing calibration

To unlock manufacturing calibration, press and hold in the OPEN key while turning on the power.

### Measuring the synthesizer voltage

The 3Hz synthesizer signal amplitude must be accurately measured using the digital multimeter listed in Table 2-13. Proceed as follows:

1. Connect the synthesizer output to the digital multimeter input jacks (see Figure 2-5).
2. Turn on the synthesizer and multimeter, and allow a one-hour warm-up period before measuring.
3. Set the synthesizer to output a 1V RMS sine wave at 3Hz; measure and record the signal amplitude.

## Front panel calibration

1. Connect the low-thermal short to the rear panel input jacks, and select the rear inputs with the INPUTS switch. Allow three minutes for thermal equilibrium.
2. Press in and hold the OPEN key while turning on the power.
3. Press SHIFT then CAL, select RUN, then enter the appropriate calibration code (default: 002000).
4. Select ALL at the CAL:RUN prompt.
5. Press ENTER.
6. Perform the entire front panel comprehensive calibration procedure discussed earlier in this section.
7. Connect the synthesizer to the Model 2000 INPUT jacks as shown in Figure 2-5. Select the front input jacks with the INPUTS switch.
8. After the last AC current calibration step, the instrument will prompt you to enter 3Hz at 1V RMS and 1kHz. For each prompt:
  - Low frequency cal: Set the synthesizer to output a 1V RMS, 3Hz sine wave. Use the left and right arrow keys, and the range keys to adjust the displayed voltage value to the value you measured and recorded earlier. Press Enter.
  - Frequency cal: Set the synthesizer to output a 1V RMS sine wave at 1kHz. Enter 1.000000kHz, then press ENTER.
9. Set the calibration dates, then save calibration constants to complete the process.

**Figure 2-5**  
Synthesizer connections for manufacturing calibration

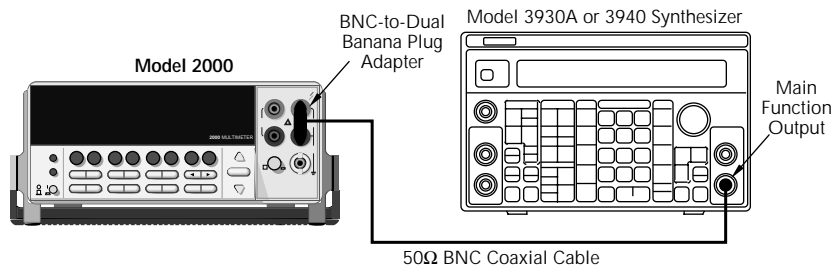

Note: Synthesizer output voltage must be accurately measured. (See text).

## SCPI command calibration

1. Connect the low-thermal short to the rear panel input jacks, and select the rear inputs with the INPUTS switch. Allow three minutes for thermal equilibrium.
2. Press in and hold the OPEN key while turning on the power.
3. Enable calibration by sending the :CODE command. For example, the default command is:

```
:CAL:PROT:CODE 'KI002000'
```

4. Initiate calibration by sending the following command:

```
:CAL:PROT:INIT
```

5. Calibrate step 0 with the following command:

```
:CAL:PROT:AC:STEP0
```

6. Perform the entire SCPI command comprehensive calibration procedure discussed earlier in this section.
7. Connect the synthesizer to the Model 2000 INPUT jacks as shown in Figure 2-5. Select the front input jacks with the INPUTS switch.
8. Set the synthesizer output to 1V RMS at 3Hz, then send the following command:

```
:CAL:PROT:AC:STEP14 <Cal_voltage>
```

Here <Cal\_voltage> is the actual 3Hz synthesizer signal amplitude you recorded earlier.

9. Set the synthesizer output to 1V RMS at 1kHz, then send the following command:

```
:CAL:PROT:AC:STEP15 1E3
```

10. Send the following commands to set calibration dates, save calibration constants, and lock out calibration:

```
:CAL:PROT:DATE <year>, <month>, <day>
```

```
:CAL:PROT:NDUE <year>, <month>, <day>
```

```
:CAL:PROT:SAVE
```

```
:CAL:PROT:LOCK
```

**NOTE** After manufacturing calibration is unlocked, you have the option of performing comprehensive, DC-only, or AC-only calibration. If you calibrate DC-only and then lock out calibration, manufacturing calibration is then locked, and you cannot then perform AC calibration. You must then unlock manufacturing calibration by holding in the OPEN key and cycling power.

---

# 3 Calibration Command Reference

# Introduction

This section contains detailed information about the various Model 2000 SCPI bus calibration commands. Section 2 of this manual covers detailed calibration procedures. For information about additional commands to control other instrument functions, refer to the Model 2000 User's Manual.

Information in this section includes:

**Command summary:** Summarizes all commands necessary to perform comprehensive and factory calibration.

**Miscellaneous calibration commands:** Gives detailed explanations of the various commands used for miscellaneous functions such as programming the calibration code and date.

**DC calibration commands:** Details those commands required to calibrate the DCV, DCA, and ohms functions.

**AC calibration commands:** Covers commands that calibrate Model 2000 ACV and ACI functions.

**Manufacturing calibration commands:** Summarizes the commands necessary to perform the manufacturing calibration steps.

**Bus error reporting:** Discusses bus calibration errors and discusses how to obtain error information.

**Detecting calibration step completion:** Covers how to determine when each calibration step is completed by using the \*OPC and \*OPC? commands.

## Command summary

Table 3-1 summarizes Model 2000 calibration commands.

**Table 3-1**  
Calibration command summary

Command	Description
:CALibration	Calibration root command.
:PROTeCted	All commands in this subsystem are protected by the calibration lock (except queries and :CODE).
:CODE '<up to 8 char. string>'	Calibration code or password (default: KI002000).
:COUNt?	Request the number of times the unit has been calibrated.
:INITiate	Initiate calibration.
:LOCK	Lock out calibration (opposite of enabling cal with :CODE command).
:LOCK?	Request comprehensive cal lock state. (0 = locked; 1 = unlocked)
:SAVE	Save cal constants to EEROM.
:DATE <year>, <month>, <day>	Send cal date to 2000.
:DATE?	Request cal date from 2000.
:NDUE <year>, <month>, <day>	Send next due cal date to 2000.
:NDUE?	Request next due cal date from 2000.
:DC	DC cal steps.
:STEP0	Rear terminal short step. <sup>1</sup>
:STEP1	Front terminal short circuit.
:STEP2 <NRf>	Open circuit.
:STEP3 <NRf>	10V DC step.
:STEP4 <NRf>	-10V DC step.
:STEP5 <NRf>	100V DC step.
:STEP6 <NRf>	1k $\Omega$ 4-wire step.
:STEP7 <NRf>	10k $\Omega$ 4-wire step.
:STEP8 <NRf>	100k $\Omega$ 4-wire step.
:STEP9 <NRf>	1M $\Omega$ 4-wire step.
:STEP10 <NRf>	10mA DC step.
:STEP11 <NRf>	100mA DC step.
:STEP12 <NRf>	1A DC step.



**Table 3-1 (cont.)**  
*Calibration command summary*

Command	Description
:CALibration :PROTeCted :AC :STEP1 :STEP2 :STEP3 :STEP4 :STEP5 :STEP6 :STEP7 :STEP8 :STEP9 :STEP10 :STEP11 :STEP12 :STEP13 :STEP14 :STEP15	Calibration root command.  AC cal steps. 10mV AC at 1kHz step. 100mV AC at 1kHz step. 100mV AC at 50kHz step. 1V AC at 1 kHz step. 1V AC at 50kHz step. 10V AC at 1kHz step. 10V AC at 50kHz step. 100V AC at 1kHz step. 100V AC at 50kHz step. 700V AC at 1kHz step. 100mA AC at 1kHz step. 1A AC at 1kHz step. 2A AC at 1kHz step. 1V AC at 3Hz step. <sup>1</sup> 1V AC at 1kHz step. <sup>1</sup>

NOTES:

1. DC:STEP0, AC:STEP14, and AC:STEP15 are one-time factory calibration points and are only valid in manufacturing calibration mode.
2. Upper case letters indicated short form of each command. For example, instead of sending ":CALibration:PROTeCted:INITiate," you can send":CAL:PROT:INIT."

## Miscellaneous calibration commands

Miscellaneous commands perform calibration functions such as programming the calibration code and date. These commands are discussed in detail in the following paragraphs.

### **:CODE** (:CALibration:PROTected:CODE)

<b>Purpose</b>	To program the calibration code or password so that you can perform the calibration procedures.
<b>Format</b>	:cal:prot:code '<char_string>'
<b>Parameter</b>	Up to an 8-character string including letters and numbers.
<b>Description</b>	The :CODE command enables the Model 2000 calibration procedures when performing these procedures over the bus. In general, this command must be sent to the unit before sending any other comprehensive or manufacturing calibration command. The default calibration code is KI002000.
<b>Notes</b>	<ul style="list-style-type: none"><li>• The :CODE command should be sent only once before performing either the comprehensive or factory calibration. Do not send :CODE before each calibration step.</li><li>• To change the code, first send the current code, then send the new code.</li></ul>
<b>Example</b>	:CAL:PROT:CODE 'KI002000'      Send default code of KI002000.

### **:COUNT?** (:CALibration:PROTected:COUNT?)

<b>Purpose</b>	To determine how many times the Model 2000 has been calibrated.
<b>Format</b>	:cal:prot:coun?
<b>Response</b>	<n>      Calibration count.
<b>Description</b>	The :COUNT? command allows you to determine how many times the Model 2000 has been calibrated.
<b>Note</b>	Use the COUNT? command to help you monitor for unauthorized calibration procedures.
<b>Example</b>	:CAL:PROT:COUN?      Request number of times the unit has been calibrated.

## :INIT (:CALibration:PROTected:INITiate)

<b>Purpose</b>	To initiate comprehensive and factory calibration procedures.	
<b>Format</b>	:cal:prot:init	
<b>Parameter</b>	None	
<b>Description</b>	The :INIT command enables Model 2000 calibration when performing these procedures over the bus. This command must be sent to the unit after sending the :CODE command, but before sending any other DC, AC, or manufacturing calibration command.	
<b>Note</b>	The :INIT command should be sent only once before performing either comprehensive, DC, AC, or factory calibration. Do not send :INIT before each calibration step.	
<b>Example</b>	:CAL:PROT:INIT	Initiate calibration.

## :LOCK (:CALibration:PROTected:LOCK)

<b>Purpose</b>	To lock out comprehensive or manufacturing calibration.	
<b>Format</b>	:cal:prot:lock	
<b>Parameter</b>	None	
<b>Description</b>	The :LOCK command allows you to lock out both comprehensive and manufacturing calibration after completing those procedures. Thus, :LOCK performs the opposite of enabling calibration with the :CODE command.	
<b>Note</b>	To unlock comprehensive calibration, send the :CODE command. To unlock manufacturing calibration, hold in the OPEN key while turning on the power.	
<b>Example</b>	:CAL:PROT:LOCK	Lock out calibration.

## :LOCK? (:CALibration:PROTected:LOCK?)

<b>Purpose</b>	To read comprehensive calibration lock status.	
<b>Format</b>	:cal:prot:lock?	
<b>Response</b>	0	Comprehensive calibration locked.
	1	Comprehensive calibration unlocked.
<b>Description</b>	The :LOCK? query requests status from the Model 2000 on calibration locked/unlocked state. Calibration must be enabled by sending the :CODE command before calibration can be performed.	
<b>Example</b>	:CAL:PROT:LOCK?	Request cal lock state.

**:SAVE** (:CALibration:PROTected:SAVE)

<b>Purpose</b>	To save calibration constants in EEROM after the calibration procedure.	
<b>Format</b>	:cal:prot:save	
<b>Parameter</b>	None	
<b>Description</b>	The :SAVE command stores internally calculated calibration constants derived during both comprehensive and manufacturing calibration in EEROM. (EEROM is non-volatile memory.) Calibration constants will be retained indefinitely once saved. Generally, :SAVE is sent after all other calibration steps (except for :LOCK).	
<b>Note</b>	Calibration will be only temporary unless the :SAVE command is sent to permanently store calibration constants.	
<b>Example</b>	:CAL:PROT:SAVE	Save calibration constants.

**:DATE** (:CALibration:PROTected:DATE)

<b>Purpose</b>	To send the calibration date to the instrument.	
<b>Format</b>	:cal:prot:date <year>, <month>, <day>	
<b>Parameters</b>	<year> = 1994 to 2093 <month> = 1 to 12 <day> = 1 to 31	
<b>Query format</b>	:cal:prot:date?	
<b>Response</b>	<year>, <month>, <day>	
<b>Description</b>	The :DATE command allows you to store the calibration date in instrument memory for future reference. You can read back the date from the instrument over the bus by using the :DATE? query or the DATES selection in the front panel CAL menu.	
<b>Note</b>	The year, month, and day parameters must be delimited by commas.	
<b>Examples</b>	:CAL:PROT:DATE 1994, 12, 16	Send cal date (12/16/94).
	:CAL:PROT:DATE?	Request cal date.

---

**:NDUE** :CALibration:PROTected:NDUE)

<b>Purpose</b>	To send the next calibration due date to the instrument.
<b>Format</b>	:cal:prot:ndue <year>, <month>, <day>
<b>Parameters</b>	<year> = 1994 to 2093 <month> = 1 to 12 <day> = 1 to 31
<b>Query format</b>	:cal:prot:ndue?
<b>Response</b>	<year>, <month>, <day>
<b>Description</b>	The :NDUE command allows you to store the date when calibration is next due in instrument memory. You can read back the next due date from the instrument over the bus by using the :NDUE? query or the front panel CAL menu.
<b>Note</b>	The next due date parameters must be delimited by commas.
<b>Examples</b>	:CAL:PROT:NDUE 1995,12,16 Send due date (12/16/95). :CAL:PROT:NDUE? Request due date.

## DC calibration commands

The :DC commands perform comprehensive (user) calibration of the DCV, DCI, and ohms functions. Table 3-2 summarizes these comprehensive calibration commands along with parameter limits.

**Table 3-2**  
*DC calibration commands*

Command	Description	Parameter limits
:CALibration		
:PROTeCted		
:DC		
:STEP1	Front terminal short circuit.	
:STEP2	Open circuit.	
:STEP3 <NRf>	10V DC calibration step.	9 to 11
:STEP4 <NRf>	-10V DC calibration step.	-9 to -11
:STEP5 <NRf>	100V DC calibration step.	90 to 110
:STEP6 <NRf>	1k $\Omega$ 4-wire calibration step.	900 to 1.1E3
:STEP7 <NRf>	10k $\Omega$ 4-wire calibration step.	9E3 to 11E3
:STEP8 <NRf>	100k $\Omega$ 4-wire calibration step.	90E3 to 110E3
:STEP9 <NRf>	1M $\Omega$ 4-wire calibration step.	900E3 to 1.1E6
:STEP10 <NRf>	10mA DC calibration step.	9E-3 to 11E-3
:STEP11 <NRf>	100mA DC calibration step.	90E-3 to 110E-3
:STEP12 <NRf>	1A DC calibration step.	0.9 to 1.1

**:STEP1** (:CALibration:PROTECTED:DC:STEP1)

<b>Purpose</b>	To perform front terminal short-circuit calibration.	
<b>Format</b>	:cal:prot:dc:step1	
<b>Parameter</b>	None	
<b>Description</b>	:STEP1 performs the short-circuit calibration step in the comprehensive calibration procedure. Connect a low-thermal short (Model 8610) to the front panel input jacks before sending this command.	
<b>Example</b>	:CAL:PROT:DC:STEP1	Perform short-circuit calibration.

**:STEP2** (:CALibration:PROTECTED:DC:STEP2)

<b>Purpose</b>	To perform front terminal open-circuit calibration.	
<b>Format</b>	:cal:prot:dc:step2	
<b>Parameter</b>	None	
<b>Description</b>	:STEP2 performs the open-circuit calibration step in the comprehensive calibration procedure. Disconnect all cables and accessories from the input jacks before sending this command.	
<b>Example</b>	:CAL:PROT:DC:STEP2	Perform open circuit calibration.

**:STEP3** (:CALibration:PROTECTED:DC:STEP3)

<b>Purpose</b>	To program the +10V comprehensive calibration step.	
<b>Format</b>	:cal:prot:dc:step3 <Cal_voltage>	
<b>Parameter</b>	<Cal_voltage> = 9 to 11 [V]	
<b>Description</b>	:STEP3 programs the +10V DC comprehensive calibration step. The allowable range of the calibration voltage parameter is from 9 to 11, but 10 is recommended for best results.	
<b>Example</b>	:CAL:PROT:DC:STEP3 10	Program 10V step.

**:STEP4** (:CALibration:PROTECTED:DC:STEP4)

<b>Purpose</b>	To program the -10V DC comprehensive calibration step.
<b>Format</b>	:cal:prot:dc:step4 <Cal_voltage>
<b>Parameter</b>	<Cal_voltage> = -9 to -11 [V]
<b>Description</b>	:STEP4 programs the -10V DC comprehensive calibration step. The allowable range of the calibration voltage parameter is from -9 to -11, but -10 is recommended for best results.
<b>Example</b>	:CAL:PROT:DC:STEP4 -10     Program -10V step.

**:STEP5** (:CALibration:PROTECTED:DC:STEP5)

<b>Purpose</b>	To program the 100V DC comprehensive calibration step.
<b>Format</b>	:cal:prot:dc:step5 <Cal_voltage>
<b>Parameter</b>	<Cal_voltage> = 90 to 110 [V]
<b>Description</b>	:STEP5 programs the 100V DC comprehensive calibration step. The allowable range of the calibration voltage parameter is from 90 to 110, but 100 is recommended for best results.
<b>Example</b>	:CAL:PROT:DC:STEP5 100     Program 100V step.

**:STEP6** (:CALibration:PROTECTED:DC:STEP6)

<b>Purpose</b>	To program the 1k $\Omega$ 4-wire comprehensive calibration step.
<b>Format</b>	:cal:prot:dc:step6 <Cal_resistance>
<b>Parameter</b>	<Cal_resistance> = 900 to 1.1E3 [ $\Omega$ ]
<b>Description</b>	:STEP6 programs the 1k $\Omega$ 4-wire resistance comprehensive calibration step. The allowable range of the calibration resistance parameter is from 900 to 1.1E3 but 1E3 is recommended for best results.
<b>Example</b>	:CAL:PROT:DC:STEP6 1E3     Program 1k $\Omega$ step.



**:STEP7** (:CALibration:PROTected:DC:STEP7)

<b>Purpose</b>	To program the 10k $\Omega$ 4-wire comprehensive calibration step.
<b>Format</b>	:cal:prot:dc:step7 <Cal_resistance>
<b>Parameter</b>	<Cal_resistance> = 9E3 to 11E3 [ $\Omega$ ]
<b>Description</b>	:STEP7 programs the 10k $\Omega$ 4-wire resistance comprehensive calibration step. The allowable range of the calibration resistance parameter is from 9E3 to 11E3, but 10E3 is recommended for best results.
<b>Example</b>	:CAL:PROT:DC:STEP7 10E3 Program 10k $\Omega$ step.

**:STEP8** (:CALibration:PROTected:DC:STEP8)

<b>Purpose</b>	To program the 100k $\Omega$ 4-wire comprehensive calibration step.
<b>Format</b>	:cal:prot:dc:step8 <Cal_resistance>
<b>Parameter</b>	<Cal_resistance> = 90E3 to 110E3 [ $\Omega$ ]
<b>Description</b>	:STEP8 programs the 100k $\Omega$ 4-wire resistance comprehensive calibration step. The allowable range of the calibration resistance parameter is from 90E3 to 110E3, but 100E3 is recommended for best results.
<b>Example</b>	:CAL:PROT:DC:STEP8 100E3 Program 100k $\Omega$ step.

**:STEP9** (:CALibration:PROTected:DC:STEP9)

<b>Purpose</b>	To program the 1M $\Omega$ comprehensive calibration step.
<b>Format</b>	:cal:prot:dc:step9 <Cal_resistance>
<b>Parameter</b>	<Cal_resistance> = 900E3 to 1.1E6 [ $\Omega$ ]
<b>Description</b>	:STEP9 programs the 1M $\Omega$ comprehensive calibration step. The allowable range of the calibration resistance parameter is from 900E3 to 1.1E6. Use the 1E6 value whenever possible, or the closest possible value.
<b>Example</b>	:CAL:PROT:DC:STEP9 1E6 Program 1M $\Omega$ calibration step.

**:STEP10** (CALibration:PROTected:DC:STEP10)

<b>Purpose</b>	To program the 10mA comprehensive calibration step.
<b>Format</b>	:cal:prot:dc:step10 <Cal_current>
<b>Parameter</b>	<Cal_current> = 9E-3 to 11E-3 [A]
<b>Description</b>	:STEP10 programs the 10mA comprehensive calibration step. The allowable range of the calibration current parameter is from 9E-3 to 11E-3. Use the 10E-3 value whenever possible for best results.
<b>Example</b>	:CAL:PROT:DC:STEP10 10E-3    Program 10mA step.

**:STEP11** (CALibration:PROTected:DC:STEP11)

<b>Purpose</b>	To program the 100mA comprehensive calibration step.
<b>Format</b>	:cal:prot:dc:step11 <Cal_current>
<b>Parameter</b>	<Cal_current> = 90E-3 to 110E-3 [A]
<b>Description</b>	:STEP11 programs the 100mA comprehensive calibration step. The allowable range of the calibration current parameter is from 90E-3 to 110E-3. Use the 100E-3 value whenever possible for best results.
<b>Example</b>	:CAL:PROT:DC:STEP11 0.1    Program 100mA step.

**:STEP12** (CALibration:PROTected:DC:STEP12)

<b>Purpose</b>	To program the 1A comprehensive calibration step.
<b>Format</b>	:cal:prot:dc:step12 <Cal_current>
<b>Parameter</b>	<Cal_current> = 0.9 to 1.1 [A]
<b>Description</b>	:STEP12 programs the 1A comprehensive calibration step. The allowable range of the calibration current parameter is from 0.9 to 1.1. Use a value of 1 whenever possible for best results.
<b>Example</b>	:CAL:PROT:DC:STEP12 1    Program 1A step.

## AC calibration commands

The :AC commands perform comprehensive (user) calibration of the ACV and ACI functions. Table 3-3 summarizes these comprehensive calibration commands.

**Table 3-3**  
*AC calibration commands*

Command	Description
:CALibration	
:PROTeCted	
:AC	
:STEP	
1	10mV AC at 1kHz calibration step.
2	100mV AC at 1kHz calibration step.
3	100mV AC at 50kHz calibration step.
4	1V AC at 1 kHz calibration step.
5	1V AC at 50kHz calibration step.
6	10V AC at 1kHz calibration step.
7	10V AC at 50kHz calibration step.
8	100V AC at 1kHz calibration step.
9	100V AC at 50kHz calibration step.
10	100V AC at 1kHz calibration step.
11	100mA AC at 1kHz calibration step.
12	1A AC at 1kHz calibration step.
13	2A AC at 1kHz calibration step.

**:AC:STEP<n>** (CALibration:PROTected:AC:STEP<n>)

<b>Purpose</b>	To program individual AC calibration steps.	
<b>Format</b>	:cal:prot:ac:step<n>	
<b>Parameters</b>	<ol style="list-style-type: none"><li>1 10mV AC at 1kHz calibration step.</li><li>2 100mV AC at 1kHz calibration step.</li><li>3 100mV AC at 50kHz calibration step.</li><li>4 1V AC at 1kHz calibration step.</li><li>5 1V AC at 50kHz calibration step.</li><li>6 10V AC at 1kHz calibration step.</li><li>7 10V AC at 50kHz calibration step.</li><li>8 100V AC at 1kHz calibration step.</li><li>9 100V AC at 50kHz calibration step.</li><li>10 100V AC at 1kHz calibration step.</li><li>11 10mA AC at 1kHz calibration step.</li><li>12 1A AC at 1kHz calibration step.</li><li>13 2A AC at 1kHz calibration step.</li></ol>	
<b>Description</b>	The :AC:STEP command programs the 13 individual AC calibration steps; <n> represents the calibration step number. The appropriate signal must be connected to the instrument when programming each step, as summarized in the parameters listed above.	
<b>Example</b>	:CAL:PROT:AC:STEP7	Program AC step 7.

# Manufacturing calibration commands

Three calibration steps are only performed at the factory or when the unit has been repaired:

:CALibration:PROTeCted:AC:STEP14	1V AC at 3Hz
:CALibration:PROTeCted:AC:STEP15	1V AC at 1kHz
:CALibration:PROTeCted:DC:STEP0	Rear terminal short circuit

## :AC:STEP<14 | 15> (:CALibration:PROTeCted:AC:STEP<14 | 15>)

<b>Purpose</b>	To program individual AC manufacturing calibration steps.
<b>Format</b>	:cal:prot:ac:step14 <Cal_voltage> :cal:prot:ac:step15 <Cal_frequency>
<b>Parameters</b>	<Cal_voltage> = 1 [1V nominal] <Cal_frequency> = 1E3 [1kHz nominal]
<b>Description</b>	The :AC:STEP command also programs the two manufacturing AC calibration steps; <n> represents the calibration step number. The appropriate signal must be connected to the instrument when programming each step, as summarized in the parameters listed above.
<b>Examples</b>	:CAL:PROT:AC:STEP14 1    Program AC step 14. :CAL:PROT:AC:STEP15 1E3    Program AC Step 15.

## :DC:STEP0 (:CALibration:PROTeCted:DC:STEP0)

<b>Purpose</b>	To perform rear terminal short-circuit calibration.
<b>Format</b>	:cal:prot:dc:step0
<b>Parameter</b>	None
<b>Description</b>	:STEP0 performs the rear short-circuit calibration step in the manufacturing calibration procedure. Connect a low-thermal short (Model 8610) to the rear panel input jacks, and select the rear inputs before sending this command.
<b>Example</b>	:CAL:PROT:DC:STEP0    Perform rear short-circuit calibration.

## Bus error reporting

Methods to determine calibration errors are discussed below. Refer to Appendix B for a summary of calibration errors and additional information on specific errors.

### Detecting calibration errors

If an error occurs during any calibration step, the Model 2000 will generate an error message. Several methods to detect calibration errors are discussed in the following paragraphs.

### Error queue

As with other Model 2000 errors, any calibration error will be reported in the bus error queue. You can read this queue by using the `:SYST:ERR?` query. The Model 2000 will respond with the appropriate error message, as summarized in Appendix B.

### Status byte EAV (Error Available) bit

Whenever an error is available in the error queue, the EAV bit (Error Available, bit 2) of the status byte will be set. Use the `*STB?` query or serial polling to obtain the status byte, then test bit 2 to see if it is set. If the EAV bit is set, an error has occurred, and you can use the `:SYST:ERR?` query to read the error and at the same time clear the EAV bit in the status byte.

### Generating an SRQ on error

To program the instrument to generate an SRQ when an error occurs, send the following command: `*SRE 4`. This command will enable SRQ when the EAV bit is set. You can then read the status byte and error queue as outlined above to check for errors, and so determine the exact nature of the error.

---

# Detecting calibration step completion

When sending calibration commands over the remote interface, you must wait until the instrument completes the present operation before sending a command. You can use either `*OPC?` or `*OPC` to help determine when each calibration step is completed.

## Using the `*OPC?` query

With the `*OPC?` (operation complete) query, the instrument will place an ASCII 1 in the output queue when it has completed each step. To determine when the OPC response is ready, do the following:

1. Repeatedly test the MAV bit (Message Available, bit 4) in the status byte, and wait until it is set. (You can request the status byte by using the `*STB?` query or by serial polling.)
2. When MAV is set, a message is available in the output queue, and you can read the output queue and test for an ASCII 1.
3. After reading the output queue, repeatedly test MAV until it clears. At this point, the calibration step is completed.

## Using the `*OPC` command

The `*OPC` (operation complete) command can also be used to detect the completion of each calibration step. To use `*OPC` to detect the end of each calibration step, you must do the following:

1. Enable operation complete by sending `*ESE 1`. This command sets the OPC (operation complete) in the standard event enable register, allowing operation complete status from the standard event status register to set the ESB (event summary bit) in the status byte when operation complete is detected.
2. Send the `*OPC` command immediately following each calibration command. For example:  
`:CAL:PROT:DC:STEP1;*OPC`

Note that you must include the semicolon (;) to separate the two commands and that the `*OPC` command must appear on the same line as the calibration command.

3. After sending a calibration command, repeatedly test the ESB bit (Event Summary, bit 5) in the status byte until it is set. (Use either the `*STB?` query or serial polling to request the status byte.)
4. Once operation complete has been detected, clear OPC status using one of two methods:  
(1) Use the `*ESR?` query, then read the response to clear the standard event status register, or (2) Send the `*CLS` command to clear the status registers.

Note that sending `*CLS` will also clear the error queue and operation complete status.

## Generating an SRQ on calibration complete

An SRQ (service request) can be used to detect operation complete instead of repeatedly polling the Model 2000. To use this method, send both \*ESE 1 and \*SRE 32 to the instrument, then include the \*OPC command at the end of each calibration command line, as covered above. Refer to your controller's documentation for information on detecting and servicing SRQs.



---

# A Specifications

# 2000 6<sup>1</sup>/<sub>2</sub>-Digit Multimeter Specifications

## DC CHARACTERISTICS

CONDITIONS: MED (1 PLC)<sup>1</sup> or SLOW (10 PLC)  
or MED (1 PLC) with filter of 10

ACCURACY: ±(ppm of reading + ppm of range)  
(ppm = parts per million) (e.g., 10ppm = 0.001%)

Function	Range	Resolution	Test Current Or Burden Voltage (±5%)	Input Resistance	24 Hour <sup>14</sup> 23°C ±1°	90 Day 23°C ±5°	1 Year 23°C ±5°	Temperature Coefficient 0°-18°C & 28°-50°C
<b>Voltage</b>	100.0000 mV	0.1 μV		> 10 GΩ	30 + 30	40 + 35	50 + 35	2 + 6
	1.000000 V	1.0 μV		> 10 GΩ	15 + 6	25 + 7	30 + 7	2 + 1
	10.00000 V	10 μV		> 10 GΩ	15 + 4	20 + 5	30 + 5	2 + 1
	100.0000 V	100 μV		10 MΩ ±1%	15 + 6	30 + 6	45 + 6	5 + 1
	1000.000 V <sup>9</sup>	1 mV		10 MΩ ±1%	20 + 6	35 + 6	45 + 6	5 + 1
<b>Resistance<sup>15</sup></b>	100.0000 Ω	100 μΩ	1 mA		30 + 30	80 + 40	100 + 40	8 + 6
	1.000000 kΩ	1 mΩ	1 mA		20 + 6	80 + 10	100 + 10	8 + 1
	10.00000 kΩ	10 mΩ	100 μA		20 + 6	80 + 10	100 + 10	8 + 1
	100.0000 kΩ	100 mΩ	10 μA		20 + 6	80 + 10	100 + 10	8 + 1
	1.000000 MΩ <sup>16</sup>	1 Ω	10 μA		20 + 6	80 + 10	100 + 10	8 + 1
	10.00000 MΩ <sup>11,16</sup>	10 Ω	700 nA // 10M Ω		150 + 6	200 + 10	400 + 10	70 + 1
	100.0000 MΩ <sup>11,16</sup>	100 Ω	700 nA // 10M Ω		800 + 30	1500 + 30	1500 + 30	385 + 1
<b>Current</b>	10.00000 mA	10 nA	< 0.15 V		60 + 30	300 + 80	500 + 80	50 + 5
	100.0000 mA	100 nA	< 0.03 V		100 + 300	300 + 800	500 + 800	50 + 50
	1.000000 A	1 μA	< 0.3 V		200 + 30	500 + 80	800 + 80	50 + 5
	3.00000 A	10 μA	< 1 V		1000 + 15	1200 + 40	1200 + 40	50 + 5
<b>Continuity 2W</b>	1 kΩ	100 mΩ	1 mA		40 + 100	100 + 100	120 + 100	8 + 1
<b>Diode Test</b>	3.00000 V	10 μV	1 mA		20 + 6	30 + 7	40 + 7	8 + 1
	10.00000 V	10 μV	100 μA		20 + 6	30 + 7	40 + 7	8 + 1
	10.00000 V	10 μV	10 μA		20 + 6	30 + 7	40 + 7	8 + 1

# 2000 6½-Digit Multimeter Specifications

## DC Operating Characteristics<sup>2</sup>

Function	Digits	Readings/s	PLCs <sup>8</sup>
DCV (all ranges),	6½ <sup>3, 4</sup>	5	10
DCI (all ranges),	6½ <sup>3, 7</sup>	30	1
and Ohms	6½ <sup>3, 5</sup>	50	1
(<10M range)	5½ <sup>3, 5</sup>	270	0.1
	5½ <sup>5</sup>	500	0.1
	5½ <sup>5</sup>	1000	0.04
	4½ <sup>5</sup>	2000	0.01

## DC System Speeds<sup>2, 6</sup>

**RANGE CHANGE<sup>3</sup>:** 50/s.

**FUNCTION CHANGE<sup>3</sup>:** 45/s.

**AUTORANGE TIME<sup>3, 10</sup>:** <30 ms.

**ASCII READINGS TO RS-232 (19.2k BAUD):** 55/s.

**MAX. INTERNAL TRIGGER RATE:** 2000/s.

**MAX. EXTERNAL TRIGGER RATE:** 500/s.

## DC General

**LINEARITY OF 10VDC RANGE:** ±(2ppm of reading + 1ppm of range).

**DCV, Ω, TEMPERATURE, CONTINUITY, DIODE TEST INPUT PROTECTION:** 1000V, all ranges.

**MAXIMUM 4WΩ LEAD RESISTANCE:** 10% of range per lead for 100Ω and 1kΩ ranges; 1kΩ per lead for all other ranges.

**DC CURRENT INPUT PROTECTION:** 3A, 250V fuse.

**SHUNT RESISTOR:** 0.1Ω for 3A, 1A and 100mA ranges. 10Ω for 10mA range.

**CONTINUITY THRESHOLD:** Adjustable 1Ω to 1000Ω.

**AUTOZERO OFF ERROR:** Add ±(2ppm of range error + 5μV) for <10 minutes and ±1°C change.

**OVERRANGE:** 120% of range except on 1000V, 3A and Diode.

## Speed and Noise Rejection

Rate	Readings/s	Digits	RMS Noise		
			10V Range	NMRR <sup>12</sup>	CMRR <sup>13</sup>
10 PCL	5	6½	< 1.5 μV	60 dB	140 dB
1 PCL	50	6½	< 4 μV	60 dB	140 dB
0.1 PCL	500	5½	< 22 μV	–	80 dB
0.01 PCL	2000	4½	< 150 μV	–	80 dB

## DC Notes

<sup>1</sup> Add the following to “ppm of range” uncertainty: 1V and 100V, 2ppm; 100mV, 15ppm; 100Ω, 15ppm; <1MΩ, 2ppm; 10mA and 1A, 10ppm; 100mA, 40ppm.

<sup>2</sup> Speeds are for 60 Hz operation using factory default operating conditions (\*RST). Autorange off, Display off, Trigger delay = 0.

<sup>3</sup> Speeds include measurement and binary data transfer out the GPIB.

<sup>4</sup> Auto zero off.

<sup>5</sup> Sample count = 1024, auto zero off.

<sup>6</sup> Auto zero off, NPLC = 0.01.

<sup>7</sup> Ohms = 24 readings/second.

<sup>8</sup> 1 PLC = 16.67ms @ 60Hz, 20ms @ 50Hz/400Hz. The frequency is automatically determined at power up.

<sup>9</sup> For signal levels >500V, add 0.02ppm/V uncertainty for the portion exceeding 500V.

<sup>10</sup> Add 120ms for ohms.

<sup>11</sup> Must have 10% matching of lead resistance in Input HI and LO.

<sup>12</sup> For line frequency ±0.1%.

<sup>13</sup> For 1kΩ unbalance in LO lead.

<sup>14</sup> Relative to calibration accuracy.

<sup>15</sup> Specifications are for 4-wire ohms. For 2-wire ohms, add 1Ω additional uncertainty.

<sup>16</sup> For rear inputs, add the following to Temperature Coefficient “ppm of reading” uncertainty: 10MΩ 70ppm, 100MΩ 385ppm. Operating environment specified for 0° to 50°C and 50% RH at 35°C.

# 2000 6½-Digit Multimeter Specifications

## TRUE RMS AC VOLTAGE AND CURRENT CHARACTERISTICS

ACCURACY<sup>1</sup>:  $\pm(\% \text{ of reading} + \% \text{ of range}), 23^\circ\text{C} \pm 5^\circ\text{C}$

Voltage Range	Resolution	Calibration Cycle	3 Hz-10 Hz	10 Hz-20 kHz	20 kHz-50 kHz	50 kHz-100 kHz	100 kHz-300 kHz
100.0000 mV	0.1 $\mu\text{V}$						
1.000000 V	1.0 $\mu\text{V}$	90 Days	0.35 + 0.03	0.05 + 0.03	0.11 + 0.05	0.60 + 0.08	4 + 0.5
10.00000 V	10 $\mu\text{V}$						
100.0000 V	100 $\mu\text{V}$	1 Year	0.35 + 0.03	0.06 + 0.03	0.12 + 0.05	0.60 + 0.08	4 + 0.5
750.000 V	1 mV						

Temperature Coefficient/ $^\circ\text{C}$ <sup>8</sup>	3 Hz-10 Hz	10 Hz-20 kHz	20 kHz-50 kHz	50 kHz-100 kHz	100 kHz-300 kHz
	0.035 + 0.003	0.005 + 0.003	0.006 + 0.005	0.01 + 0.006	0.03 + 0.01

Current Range	Resolution	Calibration Cycle	3 Hz-10 Hz	10 Hz-5 kHz
1.000000 A	1 $\mu\text{A}$	90 Day/1 Year	0.30 + 0.04	0.10 + 0.04
3.000000 <sup>9</sup> A	10 $\mu\text{A}$	90 Day/1 Year	0.35 + 0.06	0.15 + 0.06

Temperature Coefficient/ $^\circ\text{C}$ <sup>8</sup>	3 Hz-10 Hz	10 Hz-5 kHz
	0.035 + 0.006	0.015 + 0.006

### High Crest Factor Additional Error $\pm(\% \text{ of reading})$ <sup>7</sup>

<b>CREST FACTOR:</b>	1-2	2-3	3-4	4-5
<b>ADDITIONAL ERROR:</b>	0.05	0.15	0.30	0.40

### AC Operating Characteristics<sup>2</sup>

Function	Digits	Readings/s	Rate	Bandwidth
ACV	6½ <sup>3</sup>	2s/reading	SLOW	3 Hz-300kHz
(all ranges),	6½ <sup>3</sup>	1.4	MED	30 Hz-300kHz
and ACI	6½ <sup>4</sup>	4.8	MED	30 Hz-300kHz
(all ranges)	6½ <sup>3</sup>	2.2	FAST	300 Hz-300kHz
	6½ <sup>4</sup>	35	FAST	300 Hz-300kHz

### Additional Low Frequency Errors $\pm(\% \text{ of reading})$

	SLOW	MED	FAST
20Hz - 30Hz	0	0.3	—
30Hz - 50Hz	0	0	—
50Hz - 100Hz	0	0	1.0
100Hz - 200Hz	0	0	0.18
200Hz - 300Hz	0	0	0.10
> 300Hz	0	0	0

### AC System Speeds<sup>2,5</sup>

**FUNCTION/RANGE CHANGE**<sup>6</sup>: 4/s.

**AUTORANGE TIME**: <3 s.

**ASCII READINGS TO RS-232 (19.2k BAUD)**<sup>4</sup>: 50/s.

**MAX. INTERNAL TRIGGER RATE**<sup>4</sup>: 300/s.

**MAX. EXTERNAL TRIGGER RATE**<sup>4</sup>: 300/s.

### AC General

**INPUT IMPEDANCE**: 1M $\Omega$   $\pm$ 2% paralleled by <100pF.

**ACV INPUT PROTECTION**: 1000Vp.

**MAXIMUM DCV**: 400V on any ACV range.

**ACI INPUT PROTECTION**: 3A, 250V fuse.

**BURDEN VOLTAGE**: 1A Range: <0.3V rms. 3A Range: <1V rms.

**SHUNT RESISTOR**: 0.1 $\Omega$  on all ACI ranges.

**AC CMRR**: >70dB with 1k $\Omega$  in LO lead.

**MAXIMUM CREST FACTOR**: 5 at full scale.

**VOLT HERTZ PRODUCT**:  $\leq 8 \times 10^7$  V·Hz.

**OVERRANGE**: 120% of range except on 750V and 3A ranges.

### AC Notes

<sup>1</sup> Specifications are for SLOW rate and sinewave inputs >5% of range.

<sup>2</sup> Speeds are for 60 Hz operation using factory default operating conditions (\*RST). Auto zero off, Auto range off, Display off, includes measurement and binary data transfer out the GPIB.

<sup>3</sup> 0.01% of step settling error. Trigger delay = 400ms.

<sup>4</sup> Trigger delay = 0.

<sup>5</sup> DETector: BANDwidth 300, NPLC = 0.01.

<sup>6</sup> Maximum useful limit with trigger delay = 175ms.

<sup>7</sup> Applies to non-sinewaves >5Hz.

<sup>8</sup> Applies to 0°-18°C and 28°-50°C.

<sup>9</sup> For signal levels > 2.2A, add additional 0.4% to "of reading" uncertainty.

# 2000 6½-Digit Multimeter Specifications

## FREQUENCY AND PERIOD CHARACTERISTICS<sup>1,2</sup>

ACV Range	Frequency Range	Period Range	Gate Time	Resolution ±(ppm of reading)	Accuracy 90 Day/1 Year ±(% of reading)
100 mV to 750 V	3 Hz to 500 kHz	333 ms to 2 μs	1 s (SLOW)	0.3	0.01

### Frequency Notes

<sup>1</sup> Specifications are for squarewave inputs >10% of ACV range, except 100mV range. On 100mV range frequency must be >10Hz if voltage is <20mV.

<sup>2</sup> 20% overrange on all ranges except 750V range.

## TEMPERATURE CHARACTERISTICS

### Thermocouple<sup>2,3,4</sup>

Type	Range	Resolution	Relative to Reference Junction	90 Day/1 Year (23°C ±5°C) Accuracy <sup>1</sup> Using 2001-TCSCAN <sup>5</sup>
J	-200 to + 760°C	0.001°C	±0.5°C	±0.65°C
K	-200 to + 1372°C	0.001°C	±0.5°C	±0.70°C
T	-200 to + 400°C	0.001°C	±0.5°C	±0.68°C

### Temperature Notes

<sup>1</sup> For temperatures <-100°C, add ±0.1°C and >900°C add ±0.3°C.

<sup>2</sup> Temperature can be displayed in °C, K or °F.

<sup>3</sup> Accuracy based on ITS-90.

<sup>4</sup> Exclusive of thermocouple error.

<sup>5</sup> Specifications apply to channels 2-6. Add 0.06°C/channel from channel 6.

## INTERNAL SCANNER SPEED<sup>4</sup>

### MAXIMUM INTERNAL SCANNER RATES

RANGE: Channels/s<sup>1</sup>

TRIGGER DELAY = 0

DCV <sup>2</sup>	ACV <sup>2,3</sup>	2-Wire Ohms <sup>2</sup>	4-Wire Ohms <sup>2</sup>	Temperature <sup>4</sup>
All : 110	All : 100	All : 105	<10MΩ : 33	All : 60
<b>Trigger Delay = Auto</b>				
DCV <sup>2</sup>	ACV <sup>2,3</sup>	2-Wire Ohms <sup>2</sup>	4-Wire Ohms <sup>2</sup>	Temperature <sup>4</sup>
0.1V : 105	All : 1.8	100Ω : 85	100Ω : 29	All : 60
1V : 105		1kΩ : 85	1kΩ : 29	
10V : 105		10kΩ : 42	10kΩ : 22	
100V : 70		100kΩ : 28	100kΩ : 18	
1000V : 70		1MΩ : 8	1MΩ : 7	
		10MΩ : 5	10MΩ : 5	
		100MΩ : 3	100MΩ : 3	

### Internal Scanner Speed Notes

<sup>1</sup> Speeds are for 60Hz operation using factory default operating conditions (\*RST). Auto Zero off, Auto Range off, Display off, sample count = 1024.

<sup>2</sup> NPLC = 0.01.

<sup>3</sup> DETector: BANDwidth 300.

<sup>4</sup> 10-channel card specification. See individual card specifications for options other than 10-channel card.

# 2000 6<sup>1</sup>/<sub>2</sub>-Digit Multimeter Specifications

---

## TRIGGERING AND MEMORY

**READING HOLD SENSITIVITY:** 0.01%, 0.1%, 1%, or 10% of reading.

**TRIGGER DELAY:** 0 to 99 hrs (1ms step size).

**EXTERNAL TRIGGER LATENCY:** 200 $\mu$ s + <300 $\mu$ s jitter with autozero off, trigger delay = 0.

**MEMORY:** 1024 readings.

---

## MATH FUNCTIONS

Rel, Min/Max/Average/StdDev (of stored reading), dB, dBm, Limit Test, %, and mX + b with user defined units displayed.

**dBm REFERENCE RESISTANCES:** 1 to 9999 $\Omega$  in 1 $\Omega$  increments.

---

## STANDARD PROGRAMMING LANGUAGES

SCPI (Standard Commands for Programmable Instruments)  
Keithley 196/199  
Fluke 8840A, 8842A

---

## REMOTE INTERFACE

GPIB (IEEE-488.1, IEEE-488.2) and RS-232C.

## GENERAL

**POWER SUPPLY:** 100V / 120V / 220V / 240V  $\pm$ 10%.

**LINE FREQUENCY:** 45Hz to 66Hz and 360Hz to 440Hz, automatically sensed at power-up.

**POWER CONSUMPTION:** 22 VA.

**OPERATING ENVIRONMENT:** Specified for 0°C to 50°C. Specified to 80% R.H. at 35°C.

**STORAGE ENVIRONMENT:** -40°C to 70°C.

**WARRANTY:** 3 years.

**EMC:** Complies with European Union Directive 89/336/EEC, EN61326-1.

**SAFETY:** Conforms to European Union Directive 73/23/EEC EN61010-1, CAT II.

**VIBRATION:** MIL-PRF-28800F Class 3 Random.

**WARMUP:** 1 hour to rated accuracy.

**DIMENSIONS: Rack Mounting:** 89mm high  $\times$  213mm wide  $\times$  370mm deep (3 $\frac{1}{2}$  in.  $\times$  8 $\frac{3}{8}$  in.  $\times$  14 $\frac{7}{16}$  in.).

**Bench Configuration (with handle and feet):** 104mm high  $\times$  238mm wide  $\times$  370mm deep (4 $\frac{1}{8}$  in.  $\times$  9 $\frac{3}{8}$  in.  $\times$  14 $\frac{7}{16}$  in.).

**NET WEIGHT:** 2.9kg (6.3 lbs).

**SHIPPING WEIGHT:** 5kg (11 lbs).

**VOLT HERTZ PRODUCT:**  $\leq 8 \times 10^7$  V $\cdot$ Hz.

Specifications are subject to change without notice.

# Accuracy calculations

The information below discusses how to calculate accuracy for both DC and AC characteristics.

## Calculating DC characteristics accuracy

DC characteristics accuracy is calculated as follows:

$$\text{Accuracy} = \pm(\text{ppm of reading} + \text{ppm of range})$$

$$(\text{ppm} = \text{parts per million, and } 10\text{ppm} = 0.001\%)$$

As an example of how to calculate the actual reading limits, assume that you are measuring 5V on the 10V range. You can compute the reading limit range from one-year DCV accuracy specifications as follows:

$$\begin{aligned} \text{Accuracy} &= \pm(30\text{ppm of reading} + 5\text{ppm of range}) \\ &\pm[(30\text{ppm} \times 5\text{V}) + (5\text{ppm} \times 10\text{V})] \\ &\pm(150\mu\text{V} + 50\mu\text{V}) \\ &\pm 200\mu\text{V} \end{aligned}$$

Thus, the actual reading range is:  $5\text{V} \pm 200\mu\text{V}$ , or from 4.9998V to 5.0002V

DC current and resistance calculations are performed in exactly the same manner using the pertinent specifications, ranges, and input signal values.

## Calculating AC characteristics accuracy

AC characteristics accuracy is calculated similarly, except that AC specifications are given as follows:

$$\text{Accuracy} = \pm(\% \text{ of reading} + \% \text{ of range})$$

As an example of how to calculate the actual reading limits, assume that you are measuring 120V, 60Hz on the 750V range. You can compute the reading limit range from ACV one-year accuracy specifications as follows:

$$\begin{aligned} \text{Accuracy} &= \pm(0.06\% \text{ of reading} + 0.03\% \text{ of range}) \\ &\pm[(0.0006 \times 120\text{V}) + (0.0003 \times 750\text{V})] \\ &\pm(0.072\text{V} + 0.225\text{V}) \\ &\pm 0.297\text{V} \end{aligned}$$

In this case, the actual reading range is:  $120\text{V} \pm 0.297\text{V}$ , or from 119.703V to 120.297V

AC current calculations are performed in exactly the same manner using the pertinent specifications, ranges, and input signal values.

## Calculating dBm characteristics accuracy

As an example of how to calculate the actual reading limits for a 13dBm measurement with a reference impedance of  $50\Omega$ , assume an applied signal  $0.998815V$ . The relationship between voltage and dBm is as follows:

$$\text{dBm} = 10 \log \frac{V_{\text{IN}}^2 / R_{\text{REF}}}{1\text{mW}}$$

From the previous example on calculating DC characteristics accuracy, it can be shown that  $0.998815V$  has an uncertainty of  $\pm 36.96445\mu V$ , or  $0.998778V$  to  $0.998852V$ , using one-year specifications of the 1VDC range.

Expressing  $0.998778V$  as dBm:

$$\text{dBm} = 10 \log \frac{(0.998778V)^2 / 50\Omega}{1\text{mW}} = 13.00032\text{dBm}$$

and expressing  $0.998852V$  as dBm:

$$\text{dBm} = 10 \log \frac{(0.998852V)^2 / 50\Omega}{1\text{mW}} = 13.00032\text{dBm}$$

Thus, the actual reading range is  $13\text{dBm} \pm 0.00032\text{dBm}$ .

dBm and dB for other voltage inputs can be calculated in exactly the same manner using pertinent specifications, ranges, and reference impedances.



## Calculating dB characteristics accuracy

The relationship between voltage and dB is as follows:

$$\text{dB} = 20 \log \frac{V_{\text{IN}}}{V_{\text{REF}}}$$

As an example of how to calculate the actual readings limits for dB, with a user-defined  $V_{\text{REF}}$  of 10V, you must calculate the voltage accuracy and apply it to above equation.

To calculate a -60dB measurement, assume 10mVRMS for a  $V_{\text{REF}}$  of 10V. Using the 100mV range, one-year, 10Hz - 20kHz frequency band, and SLOW rate, the voltage limits are as follows:

$$\begin{aligned} \text{Accuracy} = & \pm[(0.06\% \text{ of reading}) + (0.03\% \text{ of range})] \\ & \pm[(0.006 \times 10\text{mV}) + (0.0003 \times 100\text{mV})] \\ & \pm[6\mu\text{V} + 30\mu\text{V}] \\ & \pm 36\mu\text{V} \end{aligned}$$

Thus, the actual reading accuracy is  $10\text{mV} \pm 36\mu\text{V}$  or 10.036mV to 9.964mV. Applying the voltage reading accuracy into the dB equation yields:

$$\text{dBm} = 20 \log \frac{10.036\text{mV}}{10\text{V}} = -59.96879\text{dB}$$

$$\text{dBm} = 20 \log \frac{9.964\text{mV}}{10\text{V}} = -60.03133\text{dB}$$

Thus, the actual reading accuracy is  $-60\text{dB} + 0.031213\text{dB}$  to  $-60\text{dB} - 0.031326\text{dB}$ .

dBm and dB for other voltage inputs can be calculated in exactly the same manner using pertinent specifications, ranges, and other reference voltages.

## Additional derating factors

In some cases, additional derating factors must be applied to calculate certain accuracy values. For example, an additional derating factor must be added for DC voltages over 500V. Before calculating accuracy, study the associated specification notes carefully to see if any derating factors apply.

# Optimizing measurement accuracy

The configurations listed below assume that the multimeter has had factory setups restored.

## DC voltage, DC current, and resistance:

- Select 6½ digits, 10 PLC, filter ON (up to 100 readings), fixed range.
- Use REL on DC voltage and 2-wire resistance measurements.
- Use 4-wire resistance measurements for best accuracy.

## AC voltage and AC current:

- Select 6½ digits, 10 PLC, filter ON (up to 100 readings), fixed range.

## Temperature:

- Select 6½ digits, 10 PLC, filter ON (up to 100 readings).

# Optimizing measurement speed

The configurations listed below assume that the multimeter has had factory setups restored.

## DC voltage, DC current, and resistance:

Select 3½ digits, 0.01 PLC, filter OFF, fixed range.

## AC voltage and AC current:

Select 3½ digits, 0.01 PLC, filter OFF, fixed range.

## Temperature:

- Select 3½ digits, 0.01 PLC, filter OFF.

For all functions, turn off the display and autozero and set the trigger delay to zero. Use the :SAMPLE:COUNt and READ? bus commands.



---

# **B** Error Messages

# Introduction

Errors that may occur during Model 2000 calibration are summarized in Table B-1. These errors may be requested by using the :SYST:ERR? query. The table shows the error number and error message string as sent by the instrument.

**Table B-1**  
*Error summary*

Error number	Description
+400	"10 vdc zero error"
+401	"100 vdc zero error"
+402	"10 vdc full scale error"
+403	"-10 vdc full scale error"
+404	"100 vdc full scale error"
+405	"-100 vdc full scale error"
+406	"1k 2-w zero error"
+407	"10k 2-w zero error"
+408	"100k 2-w zero error"
+409	"10M 2-w zero error"
+410	"10M 2-w full scale error"
+411	"10M 2-w open error"
+412	"1k 4-w zero error"
+413	"10k 4-w zero error"
+414	"100k 4-w zero error"
+415	"10M 4-w sense lo zero error"
+416	"1k 4-w full scale error"
+417	"10k 4-w full scale error"
+418	"100k 4-w full scale error"
+419	"1M 4-w full scale error"
+420	"10M 4-w full scale error"
+421	"10m adc zero error"
+422	"100m adc zero error"
+423	"10m adc full scale error"
+424	"100m adc full scale error"
+425	"1 adc full scale error"
+438	"Date of calibration not set"
+439	"Next date of calibration not set"
+450	"100m vac dac error"
+451	"1 vac dac error"
+452	"10 vac dac error"
+453	"100 vac dac error"
+454	"100m vac zero error"
+455	"100m vac full scale error"
+456	"1 vac zero error"
+457	"1 vac full scale error"
+458	"1 vac noise error"

**Table B-1**  
*Error summary*

<b>Error number</b>	<b>Description</b>
+459	+459, "10 vac zero error"
+460	+460, "10 vac full scale error"
+461	+461, "10 vac noise error"
+462	+462, "100 vac zero error"
+463	+463, "100 vac full scale error"
+464	+464, "750 vac zero error"
+465	+465, "750 vac full scale error"
+466	+466, "750 vac noise error"
+467	+467, "Post filter offset error"
+468	+468, "1 aac zero error"
+469	+469, "1 aac full scale error"
+470	+470, "3 aac zero error"
+471	+471, "3 aac full scale error"
+472	+472, "Input time constant error"
+473	+473, "Frequency gain error"
+500	"Calibration data invalid"
+513	"AC calibration data lost"
+514	"DC calibration data lost"
+515	"Calibration dates lost"
+610	"Questionable Calibration"

---

# C Calibration Program



## Introduction

This appendix includes a calibration program written in BASIC to help you calibrate the Model 2000. Refer to Section 2 for more details on calibration procedures, equipment, and connections.

## Computer hardware requirements

The following computer hardware is required to run the calibration program:

- IBM PC, AT, or compatible computer.
- Keithley KPC-488.2, KPS-488.2, or KPC-488.2AT, or CEC PC-488 IEEE-488 interface for the computer.
- Two shielded IEEE-488 connecting cables (Keithley Model 7007).

## Software requirements

In order to use the calibration program, you will need the following software:

- Microsoft QBasic (supplied with MS-DOS 5.0 or later).
- MS-DOS version 5.0 or later.
- HP-style Universal Language Driver, CECHP.EXE (supplied with Keithley and CEC interface cards listed above).

## Calibration equipment

The following calibration equipment is required:

- Fluke 5700A Calibrator
- Keithley Model 8610 Low thermal shorting plug

See Table 2-1 in Section 2 for detailed equipment information.

# General program instructions

1. With the power off, connect the Model 2000 and the calibrator to the IEEE-488 interface of the computer. Be sure to use shielded IEEE-488 cables for bus connections.
2. Turn on the computer, the Model 2000, and the calibrator. Allow the Model 2000 and the calibrator to warm up for at least one hour before performing calibration.
3. Make sure the Model 2002 is set for a primary address of 16. (Use the front panel GPIB key to check or change the address.)
4. Make sure the calibrator primary address is at its factory default setting of 4.
5. Make sure that the computer bus driver software (CECHP.EXE) is properly initialized.
6. Enter the QBasic editor, and type in the program below. Check thoroughly for errors, then save it using a convenient filename.

**NOTE** *The program assumes a default calibration code of KI002000. If the calibration code has been changed, modify the :CAL:PROT:CODE parameter accordingly.*

7. Run the program, and follow the prompts on the screen to perform calibration.

## Program C-1 Model 2000 calibration program

```
' Model 2000 calibration program for use with the Fluke 5700A calibrator.
' Rev. 1.0, 10/18/94

OPEN "IEEE" FOR OUTPUT AS #1           ' Open IEEE-488 output path.
OPEN "IEEE" FOR INPUT AS #2           ' Open IEEE-488 input path.
PRINT #1, "INTERM CRLF"               ' Set input terminator.
PRINT #1, "OUTTERM LF"                ' Set output terminator.
PRINT #1, "REMOTE 4 16"               ' Put 2000, 5700A in remote.
PRINT #1, "CLEAR"                     ' Send DCL.
PRINT #1, "OUTPUT 16;:SYST:PRES;*CLS" ' Initialize 2000.
PRINT #1, "OUTPUT 16;*ESE 1;*SRE 32"  ' Enable OPC and SRQ
PRINT #1, "OUTPUT 4;*RST;*CLS;STBY"   ' Reset 5700A calibrator.
PRINT #1, "OUTPUT 4;CUR_POST NORMAL"  ' Normal current output.
C$ = ":CAL:PROT:"                      ' 2000 partial command header.
'
CLS                                     ' Clear CRT.
PRINT "Model 2000 Multimeter Comprehensive Calibration Program"
PRINT #1, "OUTPUT 16;:CAL:PROT:CODE 'KI002000'" ' Send KI002000 cal code.
PRINT #1, "OUTPUT 16;:CAL:PROT:INIT"     ' Initiate calibration.
GOSUB ErrCheck
RESTORE CmdList
'
FOR I = 1 TO 25                          ' Loop for all cal points.
READ Msg$, Cmd$                          ' Read message, cal strings.
SELECT CASE I                             ' Select cal sequence.
CASE 1, 2
PRINT Msg$
GOSUB KeyCheck
CASE 3
PRINT "Connect calibrator to INPUT and SENSE jacks."
PRINT "Wait 3 minutes."
GOSUB KeyCheck
PRINT #1, "OUTPUT 4;EXTSENSE OFF"
PRINT #1, "OUTPUT 4;"; Msg$
PRINT #1, "OUTPUT 4;OPER"
```



```
DO: PRINT #1, "OUTPUT 4;ISR?"           ' Query status register.
PRINT #1, "ENTER 4"
INPUT #2, S
LOOP UNTIL (S AND &H1000)              ' Test settle bit.
RETURN
'
EndProg:                                ' Close files, end program.
BEEP: PRINT "Calibration aborted."
PRINT #1, "OUTPUT 4;STBY"
PRINT #1, "OUTPUT 16;SYST:PRES"
PRINT #1, "LOCAL 4 16"
CLOSE
END
'
CmdList:
DATA "Connect low-thermal short to inputs, wait 3 minutes.,"DC:STEP1"
DATA "Disconnect low-thermal short from inputs.,"DC:STEP2"
DATA "OUT 10 V,0 HZ","DC:STEP3 10"
DATA "OUT -10 V","DC:STEP4 -10"
DATA "OUT 100 V","DC:STEP5 100"
DATA "OUT 1 KOHM","DC:STEP6"
DATA "OUT 10 KOHM","DC:STEP7"
DATA "OUT 100 KOHM","DC:STEP8"
DATA "OUT 1 MOHM","DC:STEP9"
DATA "OUT 10 MA","DC:STEP10 10E-3"
DATA "OUT 100 MA","DC:STEP11 100E-3"
DATA "OUT 1A","DC:STEP12 1"
DATA "OUT 10 MV,1 KHZ","AC:STEP1"
DATA "OUT 100 MV,1 KHZ","AC:STEP2"
DATA "OUT 100 MV,50 KHZ","AC:STEP3"
DATA "OUT 1 V,1 KHZ","AC:STEP4"
DATA "OUT 1 V,50 KHZ","AC:STEP5"
DATA "OUT 10 V,1 KHZ","AC:STEP6"
DATA "OUT 10 V,50 KHZ","AC:STEP7"
DATA "OUT 100 V,1 KHZ","AC:STEP8"
DATA "OUT 100 V,50 KHZ","AC:STEP9"
DATA "OUT 700 V,1 KHZ","AC:STEP10"
DATA "OUT 100 MA,1 KHZ","AC:STEP11"
DATA "OUT 1 A,1 KHZ","AC:STEP12"
DATA "OUT 2 A,1 KHZ","AC:STEP13"
```

---

# Index

## Symbol

:ACSTEP <n> 3-17  
:ACSTEP<14|15> 3-18  
:CODE 3-6  
:COUNT? 3-6  
:DATE 3-8  
:DCSTEP0 3-18  
:INIT 3-7  
:LOCK 3-7  
:LOCK? 3-7  
:NDUE 3-9  
:SAVE 3-8  
:STEP1 3-11  
:STEP2 3-11  
:STEP3 3-11  
:STEP4 3-12  
:STEP5 3-12  
:STEP6 3-12  
:STEP7 3-13  
:STEP8 3-13  
:STEP9 3-13  
:STEP10 3-14  
:STEP11 3-14  
:STEP12 3-15

## A

AC calibration commands 3-16  
AC current calibration 2-13, 2-18  
AC voltage calibration 2-12, 2-18  
Accuracy calculations A-7  
Additional derating factors A-9

## B

Bus error reporting 3-18

## C

Calculating AC characteristics accuracy A-7  
Calculating dB characteristics accuracy A-9  
Calculating dBm characteristics accuracy A-8  
Calculating DC characteristics accuracy A-7  
Calibration 2-1  
Calibration code 2-5  
Calibration Command Reference 3-1  
Calibration cycle 2-6  
Calibration equipment C-2  
Calibration Program C-1  
Canceling calibration 1-6  
Command summary 3-4  
Comprehensive calibration 2-6  
Comprehensive calibration code 2-5  
Computer hardware requirements C-2

## D

DC calibration commands 3-10  
DC current calibration 2-11, 2-17  
DC voltage calibration 2-9, 2-15  
Detecting calibration errors 3-18  
Detecting calibration step completion 3-19

## E

Environmental conditions 1-3, 2-3  
Error Messages B-1  
Error queue 3-19  
Example reading limit calculation 1-5

## F

Front panel calibration 2-7, 2-21  
Front panel calibration code 2-5  
Front panel short and open calibration 2-8, 2-15

## G

General program instructions C-3  
Generating an SRQ on calibration complete 3-20  
Generating an SRQ on error 3-19

## L

Line power 1-3, 2-3  
Locking out calibration 2-19

## M

Manufacturing calibration 2-20  
Manufacturing calibration commands 3-18  
Manufacturing calibration lock 2-5  
Measuring the synthesizer voltage 2-20  
Miscellaneous calibration commands 3-6

## O

Optimizing measurement accuracy A-10  
Optimizing measurement speed A-11

## P

Performance Verification 1-1  
Performing the verification test procedures 1-6  
Preparing the Model 2000 for calibration 2-7, 2-14  
Programming the calibration code 2-5  
Programming calibration dates 2-19

## R

Recommended equipment 2-6  
Recommended test equipment 1-4, 2-20  
Resistance calibration 2-10, 2-16  
Restoring factory default 1-5

---

## S

- Saving calibration constants 2-19
- SCPI command calibration 2-14, 2-22
- Setting calibration dates 2-13
- Software requirements C-2
- Specifications A-1
- Status byte EAV (Error Available) bit 3-19

## T

- Test considerations 1-6

## U

- Unlocking manufacturing calibration 2-20
- Using the \*OPC command 3-20
- Using the \*OPC? query 3-20

## V

- Verification limits 1-5
- Verification test requirements 1-3
- Verifying AC current 1-11
- Verifying AC voltage 1-8
- Verifying DC current 1-10
- Verifying DC voltage 1-7
- Verifying resistance 1-12

## W

- Warm-up period 1-3, 2-3

---

# Service Form

Model No. \_\_\_\_\_ SerialNo. \_\_\_\_\_ Date \_\_\_\_\_

Name and Telephone No. \_\_\_\_\_

Company \_\_\_\_\_

List all control settings, describe problem and check boxes that apply to problem. \_\_\_\_\_

\_\_\_\_\_

Intermittent                       Analog output follows display                       Particular range or function bad; specify \_\_\_\_\_

IEEE failure                       Obvious problem on power-up                       Batteries and fuses are OK

Front panel operational     All ranges or functions are bad                       Checked all cables

Display or output (check one)

Drifts                       Unable to zero                       Unstable

Overload                       Will not read applied input

Calibration only                       Certificate of calibration required                       Data required

(attach any additional sheets as necessary)

Show a block diagram of your measurement including all instruments connected (whether power is turned on or not). Also, describe signal source.

Where is the measurement being performed? (factory, controlled laboratory, out-of-doors, etc.) \_\_\_\_\_

What power line voltage is used? \_\_\_\_\_ Ambient temperature? \_\_\_\_\_ °F

Relative humidity? \_\_\_\_\_ Other? \_\_\_\_\_

Any additional information. (If special modifications have been made by the user, please describe.)

\_\_\_\_\_

Be sure to include your name and phone number on this service form.

Specifications are subject to change without notice.

All Keithley trademarks and trade names are the property of Keithley Instruments, Inc. All other trademarks and trade names are the property of their respective companies.



**Keithley Instruments, Inc.**

**BELGIUM:** Keithley Instruments B.V.  
**CHINA:** Keithley Instruments China  
**FRANCE:** Keithley Instruments Sarl  
**GERMANY:** Keithley Instruments GmbH  
**GREAT BRITAIN:** Keithley Instruments Ltd.  
**INDIA:** Keithley Instruments GmbH  
**ITALY:** Keithley Instruments s.r.l.  
**KOREA:** Keithley Instruments Korea  
**NETHERLANDS:** Keithley Instruments B.V.  
**SWITZERLAND:** Keithley Instruments SA  
**TAIWAN:** Keithley Instruments Taiwan

28775 Aurora Road • Cleveland, Ohio 44139 • 440-248-0400 • Fax: 440-248-6168

**1-888-KEITHLEY (534-8453) [www.keithley.com](http://www.keithley.com)**

Bergensesteenweg 709 • B-1600 Sint-Pieters-Leeuw • 02/363 00 40 • Fax: 02/363 00 64  
Yuan Chen Xin Building, Room 705 • 12 Yumin Road, Dewai, Madian • Beijing 100029 • 8610-6202-2886 • Fax: 8610-6202-2892  
3, allée des Garays • 91127 Palaiseau Cédex • 01 64 53 20 20 • Fax: 01 60 11 77 26  
Landsberger Strasse 65 • D-82110 Germering • 089/84 93 07-40 • Fax: 089/84 93 07-34  
The Minster • 58 Portman Road • Reading, Berkshire RG30 1EA • 0118-9 57 56 66 • Fax: 0118-9 59 64 69  
Flat 2B, WILLOCRISSA • 14, Rest House Crescent • Bangalore 560 001 • 91-80-509-1320/21 • Fax: 91-80-509-1322  
Viale San Gimignano, 38 • 20146 Milano • 02-48 39 16 01 • Fax: 02-48 30 22 74  
2FL., URI Building • 2-14 Yangjae-Dong • Seocho-Gu, Seoul 137-130 • 82-2-574-7778 • Fax: 82-2-574-7838  
Postbus 559 • NL-4200 AN Gorinchem • 0183-635333 • Fax: 0183-630821  
Kriesbachstrasse 4 • 8600 Dübendorf • 01-821 94 44 • Fax: 01-820 30 81  
1FL., 85 Po Ai Street • Hsinchu, Taiwan, R.O.C. • 886-3-572-9077 • Fax: 886-3-572-9031